

# SONYKS

Take Control. Be Your Own Guide.

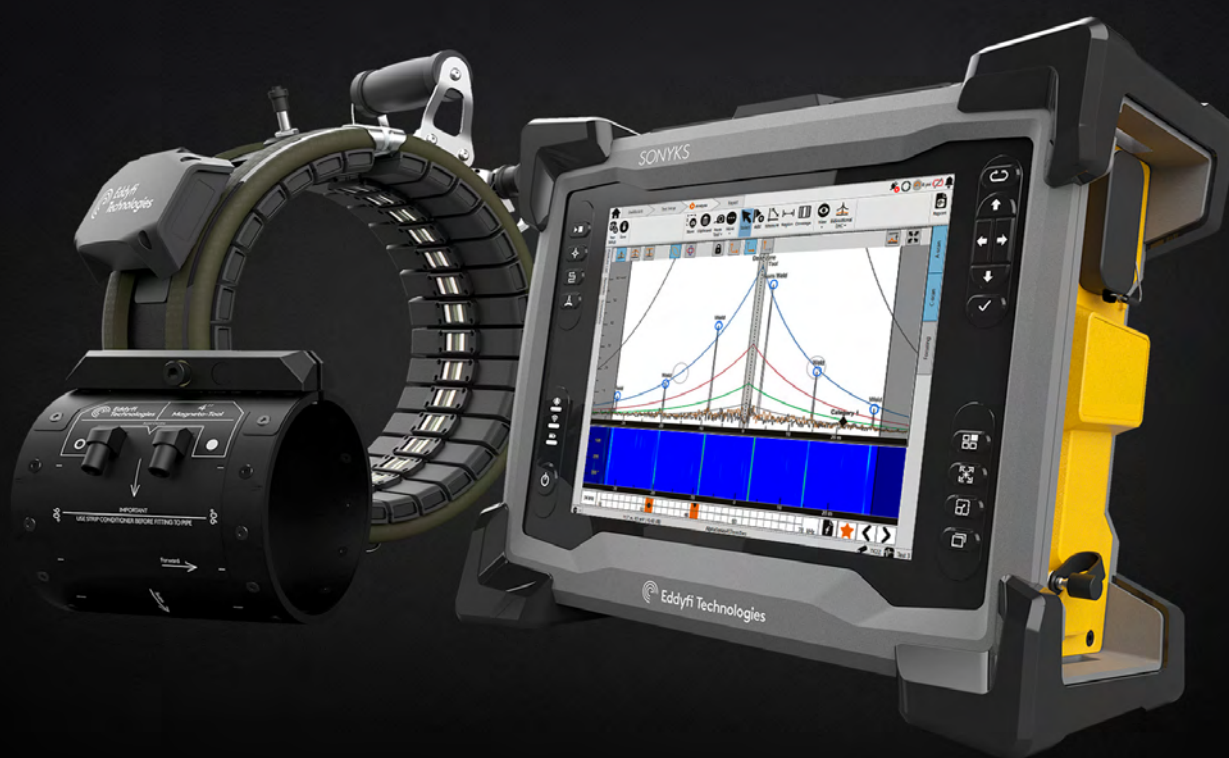

Revision History		
Version	Description	Date
1.0	Original document	May 2022
1.1	Changes due to Sonyks 1.1 software release	July 2022



© Eddyfi Canada, Inc.

3425 Rue Pierre-Ardouin

Québec (QC)

G1P 0B3 CANADA

The information in this document is accurate as of its publication. Actual products may differ from those presented herein. © 2022 Eddyfi UK Ltd. Eddyfi Technologies, Eddyfi, Teletest, Sonyks, and their associated logos are trademarks or registered trademarks of Eddyfi Canada, Inc. in the United States and/or other countries. Eddyfi Technologies reserves the right to change product offerings and specifications without notice. Eddyfi Technologies is a Previa Business Unit.

2022-07-22

# Contents

1. <i>Precautions and Conventions</i>	1
1.1 Safety Precautions	1
1.2 Safety precautions - Instrument	2
1.3 Marking and Symbols	3
1.4 Safety precautions – Sonyks Piezo-Tools and Magneto-Tools	4
1.5 Safety precautions – Accessories	4
1.6 Conventions	5
1.7 Acronyms	5
1.8 Regulatory Compliance	6
1.9 Calibration and Warranty Seals	6
1.10 Limited Warranty	6
1.11 Copyrights	7
2. <i>Introducing the Sonyks Instrument</i>	9
2.1 What is in the Box?	9
2.2 Instrument Overview	9
2.3 Positioning Sonyks	15
2.4 Starting the Sonyks instrument	16
2.5 Batteries	16
2.6 Optional Battery Charger	17
2.7 Storing Batteries	18
2.8 Optional Harness	19
3. <i>Introducing the Sonyks Software</i>	27
3.1 Project Based Inspection	27
3.2 Installation	28
3.3 Backstage	29
3.4 Creating a Project	40

3.5	Creating a Test	40
3.6	Analysis Screen	54
3.7	Reporting	83
4.	<i>Magneto and Piezo Transducer Tooling</i>	95
4.1	Sonyks Piezo Tooling	95
4.2	Magneto Tooling	101
4.3	Teletest Tooling	106
4.4	OEM Tooling	108
4.5	Tool Leads and air hoses	108
5.	<i>Maintaining Sonyks</i>	115
5.1	Cleaning Sonyks	115
5.2	Cleaning Tool Leads	115
5.3	Cleaning Collars and Modules	115
6.	<i>Updating and Upgrading Software</i>	117
6.1	Sonyks PRO (PC)	117
6.2	Sonyks GO (Embedded)	117
6.3	System Recover (Embedded)	119
7.	<i>Troubleshooting</i>	124
8.	<i>Specifications</i>	126

Chapter 1

# Precautions and conventions

# 1. Precautions and Conventions

## 1.1 Safety Precautions

### 1.1.1 Intended use of the product

Sonyks is a Non-Destructive Testing (NDT) system that uses ultrasonic guided waves to detect metal loss in either indoor or outdoor pipework. The system is used to test large volumes of material from a single test point. Sonyks employs low frequency guided waves, operating just above audible frequencies, that propagate from an array of either piezoelectric or magnetostrictive transducers fixed around a pipe. The ultrasonic signals are transmitted and received using the Sonyks instrument which has an onboard computer controlling data acquisition and post-processing. The analysis of inspection results and interaction with the system software is performed on the integrated touchscreen.

### 1.1.2 General safety precautions

- **Read instructions.** All safety and operating instructions should be read before the product is operated.
- **Retain instructions.** The safety and operating instructions should be retained for future reference.
- **Heed warnings.** All warnings on the system and in the operating instructions should be adhered to.
- **Responsibility.** All operating and usage instructions should be followed. Eddyfi Technologies will not be liable for any deterioration or damage to the equipment if it is not installed, maintained, or used in accordance with the instructions in this manual.
- **Operator proficiency.** Sonyks equipment should only be used by certified personnel.
- **Transport.** When transporting Sonyks equipment ensure that safety precautions dictated by local governing bodies are taken. When shipping the system or its individual components, always use the flight cases supplied with the system to help prevent damage.
- **Water and moisture.** Avoid using the Sonyks system in the rain or very close to open bodies of water. If operation in these conditions cannot be avoided, then take precautions (such as the erection of a portable work shelter) to avoid damage to the system or more importantly electric shock.
- **Electrical grounding.** When using the power supply unit with the system, always connect to a grounded power outlet, extension cord or power bar. Never attempt to bypass or modify this arrangement as it can result in a risk of fire or electric shock.
- **Overloading.** Do not overload the power outlets when using the power supply unit as it can result in a risk of fire or electric shock. Only connect the system to a power source corresponding to the type indicated on the rating plate.

- **Modification and replacement parts.** Do not use substitute parts or perform unauthorized modifications to the system.
- **Servicing.** Service instructions, when applicable, are intended for trained Eddyfi Technologies service personnel only. To avoid a dangerous electric shock, do not open the instrument chassis. If you encounter any problems or have questions regarding this system, contact Eddyfi or an authorized Eddyfi representative.
- **Explosive atmospheres.** The Sonyks system is not intended to be used in an 'explosive atmosphere' as defined by IECEx.

## 1.2 Safety precautions - Instrument

Observe the following safety precautions carefully when using the Sonyks Instrument.

- Dust covers should remain in place unless a cable is connected.
- Protect the unit from direct sunlight.
- Do not clean the screen with any harsh chemical cleaners. A standard glass cleaner is recommended. Please refer to Section 5.1 for more specific instructions when cleaning the Sonyks instrument.
- The instrument may be operated in light rain. When operating the instrument in wet weather, ensure that the side covers (battery compartment and peripheral connections) remain closed. Ensure that the dust covers are in place if the tool lead and air hose are disconnected. Avoid operating the instrument in heavy rain.
- Always ensure that the Sonyks system is transported in the case provided.
- When carried around site, it is recommended that the touch screen be facing your body for greater protection.
- The system bumpers offer impact protection; however, avoid excessive impact when placing the unit down.
- Ensure that connectors are free from dirt grit before using them.
- Ensure that the levers on the tool leads are depressed before removing from the unit/collar.
- Do not remove both batteries when the system is turned on. Ensure that at least one battery is always present during operation.
- When testing hot pipes, ensure that the instrument is not placed on the pipe.
- Do not use the batteries below -10°C. Battery performance may be affected below 10°C.
- To avoid damaging the Sonyks instrument, use its rear stand when operating in a tilted position. Do not use in the upright position, as it may topple over or fall off the work surface.
- If hoisting the Sonyks instrument using lifting equipment only the upper corner bumpers should be used. The instrument carry handle should not be considered as a secure attachment point.
- Always turn the instrument off before storing it in the transportation case.



<p>WARNING!</p> 	<p>WARNING</p> <p>Whenever carrying the instrument in its transport case, remove the batteries from the instrument and make sure that the battery terminals cannot come in contact with anything conductive during transport, as this poses a significant fire and explosion hazard.</p> <p>The transport case comes with two slots designed to isolate the batteries when removed from the instrument.</p> <p>When carrying the instrument, it is the user’s responsibility to make sure that the safety precautions used are in accordance with the local department of transportation (or equivalent governing body) rules and regulations (refer to the latest IATA DGR, ADR/RID and IMDG codes for further information).</p>
---	---

NOTE:

- Make sure that you do not use batteries other than those supplied by Eddyfi Technologies. Contact your Eddyfi representative for more information about replacement batteries.

### 1.3 Marking and Symbols

The following symbols appear on the instrument and pertain to safety regulations that should be carefully observed:

Symbol	Description
	<p>This label is used as a general warning sign. It indicates that you should refer to this user’s guide to obtain the necessary information for proper protection of the instrument and its users.</p>
	<p>This label acts as a reminder that you should dispose of this system in accordance with your local Waste Electrical and Electronic Equipment (WEEE) regulations. Due to its nature, this product may contain small quantities of substances known to be hazardous to the environment and to human health if released in the environment. As such, it falls under WEEE regulations and should not be disposed of in the public waste stream.</p>



## 1.4 Safety precautions – Sonyks Piezo-Tools and Magneto-Tools

Observe the following safety precautions carefully when using the Piezo-Tools and Magneto-Tools.



- Protect any tool lead connectors from ingress of dirt, dust, and moisture. Always fit a connector cap if one is present when the connector is not in use.
- Ensure that the tool lead is connected to the tool before attaching the tool lead to the instrument.
- Ensure that the pipe is free from obstruction before placing the collar on pipe.
- Ensure that the pipe surface temperature does not exceed the maximum for the collar type.
- When testing in light rain or wet conditions, regardless of the design of GWT tool, ensure that the collar is protected with a waterproof material. The collars are not waterproof therefore damage or electric shock could result if appropriate precautions are not taken.
- Ensure that the Piezo-Tool is placed on the pipe with care, avoiding any unnecessary impact that may damage the transducers.
- If hoisting the Piezo-Tool using lifting equipment, the lifting 'D' loops should be used. The carry handle should not be used to hoist the Piezo-Tool.
- Always check that the clamp is pretensioned and locked before inflating the Piezo-Tool. Failure to lock the clamp prior to inflation could cause damage to the collar or injury.
- If using an external compressor for the Piezo-Tool, ensure that the collar is not overinflated.
- Ensure that the Piezo-Tool is deflated before removing it from the pipe.
- Ensure that the Magneto-Tools are not overtightened. The maximum force should be 12 Nm (8.9 lbf-ft). Exceeding this torque value will damage the tool.
- Only tighten the Magneto-Tools with a 6mm Allen key head.
- The Sonyks equipment does not generate hazardous ultrasonic pressure. When using an external compressor to inflate the Piezo-Tool, ensure that the maximum collar pressure is not exceeded.
- The air hose contains a non-return valve in the instrument end. Disconnection of the air hose from the unit does not result in the deflation of the collar. Ensure that the collar is fully deflated before attempting to remove it from the pipe.

## 1.5 Safety precautions – Accessories

- Always inspect cables and hoses for wear or damage prior to use.
- Never use damaged cables as the system may not operate as designed or more seriously result in a risk of fire or electric shock.
- Always perform a visual inspection of connectors before mating them. Any ingress could cause damage to the system.
- When mating electrical or pneumatic connectors ensure that they are fully engaged and seated correctly.

## 1.6 Conventions

The safety indications in this document are intended to ensure your safety and the integrity of the system.

<p>WARNING!</p> 	<p>WARNING</p> <p>The warning indication calls your attention to a procedure or a practice (or the like) that, if performed incorrectly, can result in injury. Do not ignore warning indications make sure that you understand the condition before proceeding.</p>
<p>CAUTION</p> 	<p>CAUTION</p> <p>The caution indication calls your attention to a procedure or practice (or the like) that, if performed incorrectly, can result in material damage, loss of data, or both. Do not ignore caution indications make sure that you understand the condition before proceeding.</p>

### 1.6.1 Typographical

The following typographical conventions are used throughout this document:

- *Italic*

Used for file names and paths.

- **Bold**

Used to indicate menu items, named user interfaces, and place emphasis on specific words or phrases. Items in bold type are capitalized to reflect the actual interface.

- **SMALL CAPITALS**

Used to indicate instrument interface indications.

#### **IMPORTANT:**

Calls attention to important information to complete the tasks.

#### **NOTE:**

Calls attention to an operating procedure, a practice, or the like that requires special attention. Notes also indicate useful related information, but the parenthetical information is not mandatory.

## 1.7 Acronyms

GWT Guided Wave Testing

LRUT Long Range Ultrasonic Testing

UI: User interface

## 1.8 Regulatory Compliance

### 1.8.1 FCC Compliance (USA)

This equipment was tested and found to comply with the limits for a Class A digital device, pursuant to Part 15 of the FCC Rules. These limits are designed to provide reasonable protection against harmful interference when the equipment is operated in a commercial environment. This equipment generates, uses, and can radiate radio frequency energy and, if not installed and used in accordance with the user's guide, may cause harmful interference to radio communications. Operation of this equipment in a residential area is likely to cause harmful interference in which case you will be required to correct the interference at your own expense.

### 1.8.2 ICES Compliance (Canada)

This device complies with Canadian ICES-001(A).

Cet appareil est conforme à la norme NMB-001(A) du Canada.

### 1.8.3 CE Marking (EU)

Hereby, Eddyfi declares the radio equipment type Sonyks is in compliance with the essential requirements of the Radio Equipment (RED, 2014/53/EU) and Restriction of Hazardous Substance (RoHS, 2011/65/EU, 2015/863/EU and 2017/2102) directives. Please find the full EU Declaration of Conformity on the Eddyfi Technologies website (<https://eddyfi.com/declaration-c-eu>).

### 1.8.4 UKCA Marking (UK)

Hereby, Eddyfi declares the radio equipment type Sonyks is in compliance with the essential requirements of the Radio Equipment (S.I. 2017 No. 1206) and Restriction of Hazardous Substances (RoHS, S.I. 2012 No. 3032 + S.I. 2021 No. 422) Statutory Instruments. Please find the full UKCA Declaration of Conformity on the Eddyfi Technologies website (<https://eddyfi.com/declaration-c-uk>).

## 1.9 Calibration and Warranty Seals

The calibration seal is at the back of the instrument. Sonyks is also equipped with a warranty seal.

**Important:** Broken seals void the calibration certification and product warranty.

### 1.10 Limited Warranty

Eddyfi Canada, Inc. warrants the hardware to be free of any defects in materials or workmanship for a period of twelve (12) months from the date of delivery, under normal use and service. These warranties are limited to the original purchase of the product and are not transferable.

Eddyfi Canada, Inc. will repair or replace any product component or documentation, at its option and at no additional charge if found defective within the warranty period. The purchaser is responsible for returning the product to Eddyfi Canada, Inc.

Eddyfi Canada, Inc., will not be held responsible in any way whatsoever for damage resulting from improper installation, accident, misuse, or from service or modification of the product by anyone other than Eddyfi Canada, Inc., or an authorized Eddyfi Canada, Inc. service centre.

Eddyfi Canada, Inc. will not be held responsible in any way whatsoever for direct, indirect, special, incidental, or consequential damages resulting from possession, use, improper installation, accident, service, modification, or malfunction of the product (including, without limitation, damages for loss of business profits, business interruption, loss of business information, or other pecuniary loss). Eddyfi's total shall in no event exceed the purchase price of the applicable item(s).

This warranty is in lieu of all other warranties, whether oral, written, expressed, or implied, including any warranty of merchantability or fitness for a particular purpose, and no other representation or claims of any nature shall be binding on or obligate Eddyfi Canada, Inc.

This agreement is governed by the laws of the province of Québec, Canada. Each of the parties hereto irrevocably attorns to the jurisdiction of the courts of the province of Québec and further agrees to commence any litigation which may arise hereunder in the courts located in the judicial district of Québec.

## 1.11 Copyrights

This document and the products and programs it describes are protected by the Copyright Act of Canada, by laws of other countries, and by international treaties, and therefore may not be reproduced, in whole or in part, whether for sale or not, without prior written consent from Eddyfi Canada, Inc. Under copyright law, copying includes translation in other languages and formats.

© Eddyfi Canada, Inc., 2021

This document was prepared with particular attention to usage to ensure the accuracy of the information it contains. It corresponds to the version of the product manufactured prior to the date appearing on the back cover. There may, however, be some differences between this document and the product if the product was modified after publication.

The information contained in this document is subject to change without notice.

Chapter 2

# Introducing the Sonyks Instrument

## 2. Introducing the Sonyks Instrument

Thank you for purchasing the Eddyfi Technologies Sonyks system. This chapter offers an overview of the system, its components, and probes.

### 2.1 What is in the Box?

The Sonyks instrument comes with the following standard accessories:

- Two high-capacity batteries
- One power adapter (100–240 V)
- Power cords
- Safety information card
- Transport case

### 2.2 Instrument Overview

#### 2.2.1 Front

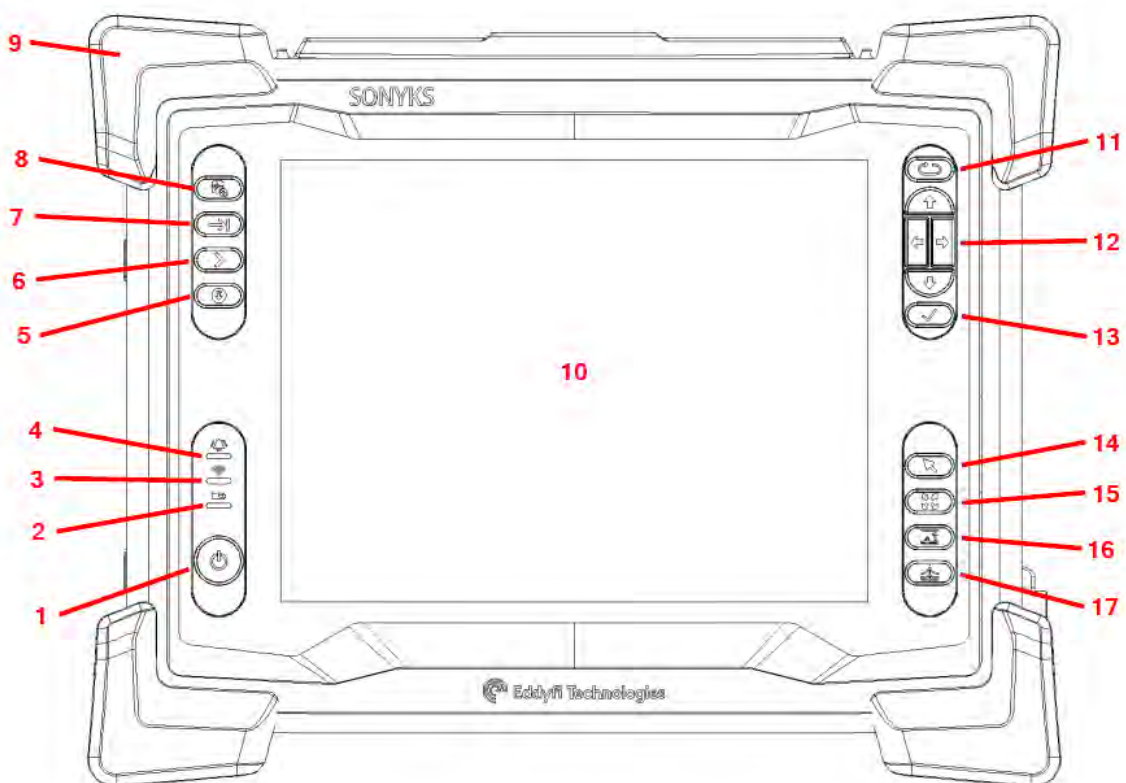

## 1. POWER BUTTON

**a) Short press** (approximately 0.5 to 4 seconds):

Use to turn the instrument on and off. The power indicator at the centre of the button behaves as follows:

**Green:** The Sonyks instrument is on.

**Blinking green:** The Sonyks instrument is in RDAU mode.

**Blinking orange:** The Sonyks instrument is on standby.

**Unlit:** The Sonyks instrument is off.

**b) Long press:** (approximately greater than 4 seconds)

If the instrument is on, a long press will initiate a forced shutdown.

If the instrument is off, a long press will activate RDAU mode, which allows the user to operate the instrument remotely from a laptop. Press and hold the power button until the alarm indicator light flashes, then release the power button. The power button light will continue to flash while in RDAU mode.

## 2. BATTERY INDICATOR

Displays the state of the batteries when the instrument is on. Depending on the power mode (DC or battery), the indicator behaves differently:

a) DC power

**Green:** Batteries fully charged.

**Blinking green:** Batteries charging.

**Red:** Battery or charger error.

**Unlit:** No batteries.

b) Battery power

**Unlit:** Remaining charge over 40%.

**Orange:** Remaining charge 20–40%.

**Blinking yellow:** Remaining charge less than 20%.

**Red:** Battery error.

## 3. WI-FI INDICATOR

Displays the Wi-Fi status. When the indicator is lit, the Wi-Fi is enabled. When it is off, the Wi-Fi is disabled.

## 4. ALARM INDICATOR

Used to display user-programmed errors. The indicator remains unlit until it detects a predefined error condition, at which time it lights red.

## 5. SAVE

Used to save a file or analysis.

## 6. NEXT

Used to progress through the acquisition stages.

## 7. TAB

Used to switch between the displayed entry fields on a given page.

## 8. NEW

Used to start a new test setup.

## 9. HEAVY-DUTY BUMPERS

The four corner bumpers provide shock absorption and support for the Sonyks instrument at an angle when it is set on a flat surface. The bumpers are also hooked for harnessing.

## 10. MULTI-TOUCH DISPLAY

10.4", non-reflective, backlit, high-resolution display.

## 11. KEYPAD ARROW MODE

Select/Disable touchscreen button

A long press disables the touchscreen. Short presses toggle through the keypad modes depending on the active view. This function is only available on the analysis screen.

## 12. KEYPAD ARROWS

Use these arrows to navigate the Sonyks software interface according to the selected mode.

## 13. ENTER BUTTON

Equivalent to the enter key for the on-screen keyboard. In text boxes this acts as a carriage return.

## 14. TOUCH MODE

Changes the function of the arrow keys dependant on which mode is active:

- **Frequency:** The left and right keys are used to through the test frequencies. The up and down keys are used to navigate through bookmarked test frequencies.
- **Zoom:** The right key zooms in the x-axis and the left key zooms out the x-axis. The up key zooms in the y-axis and the down key zooms out the y-axis.
- **Pan:** The left key pans the scans left, the right key pans the scans right, the up key pans the scans up and the down key pans the scans down.
- **Add:** A crosshair will appear, and the left and right keys move the crosshair from peak to peak. Pressing the tick button then adds a feature and opens the radial menu. Subsequent adds on other peaks using the tick button then add that initial choice of feature.
- **Measure:** The arrow keys move the active handle of the measurement tool in the direction selected. The tick button cycles the active measurement tool handle.
- **Add region:** Selecting the 'Region' icon in the A-Scan ribbon activates

this mode; a blue vertical line will appear on the A-Scan. The left and right keys move the vertical line left and right on along the x-axis. The tick button fixes the start of the region, and the left and right buttons can be used to drag the region to a desired length. Clicking the tick button again will end the region.

- **Curtains:** This is similar in behaviour to 'Add region'. When 'Coverage' is clicked in the A-Scan ribbon a pair of diagnostic length curtains appear with the bold, black vertical line being active. Adjust the position of the active curtain using the left and right keys, then toggle to the other curtain using the tick button.

## 15. ZOOM OUT

Scales the A-scan to full page. Zooms out to full diagnostic length and maximum signal amplitude.

## 16. AUTO FIT

Auto scales the current A-scan view trace to fit the window y-scale.

## 17. A-SCAN SCALE

Switches between Linear, Logarithmic and Time-Corrected Gain A-scan viewing modes.



### 2.2.2 Rear

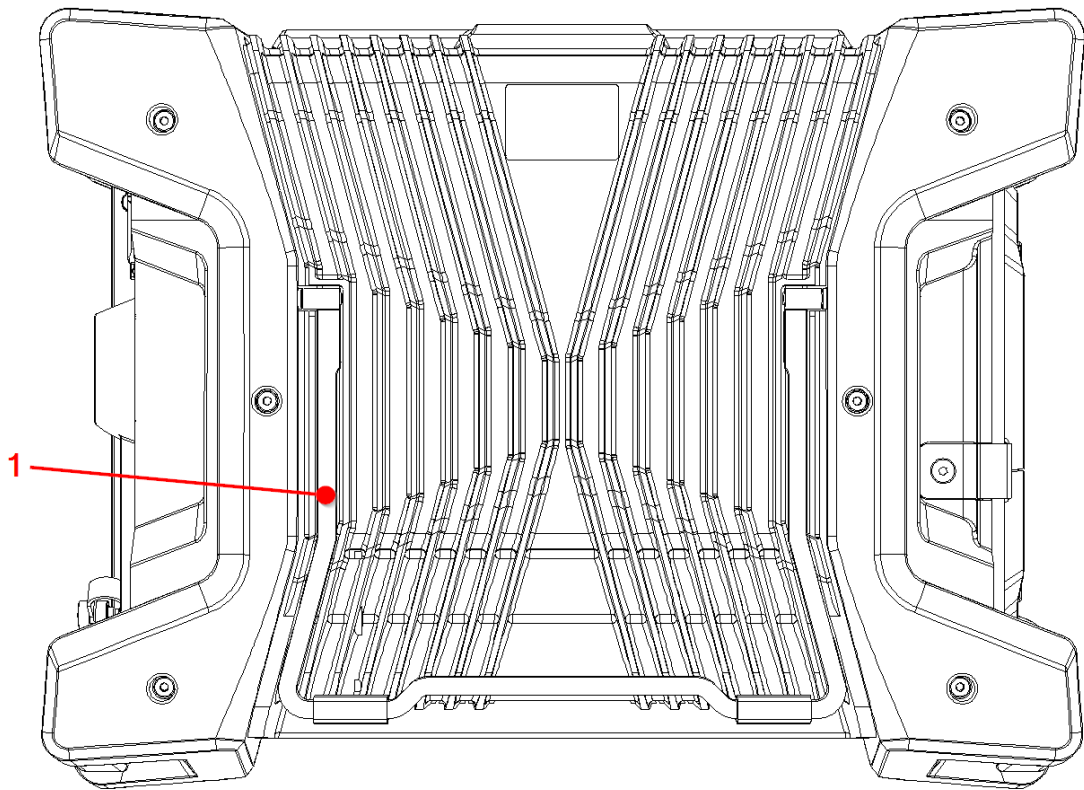

#### 1. INSTRUMENT STAND

The stand retracts outward to hold the instrument at an angle, preventing the instrument from tilting over horizontally.

### 2.2.3 Right

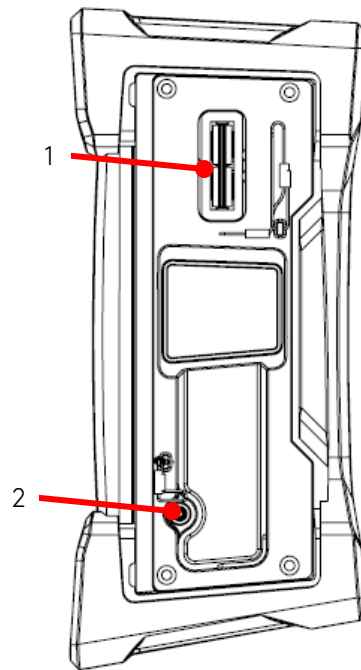

#### 1. TOOL LEAD CONNECTOR

Connect the Guided Wave tooling to this connector. The tool lead connector is a 100-pin I-PEX MINIDOCK™ Standard.

#### 2. PUMP CONNECTION

Connect the air hose to this valve to inflate the piezoelectric collars.

## 2.2.4 Left

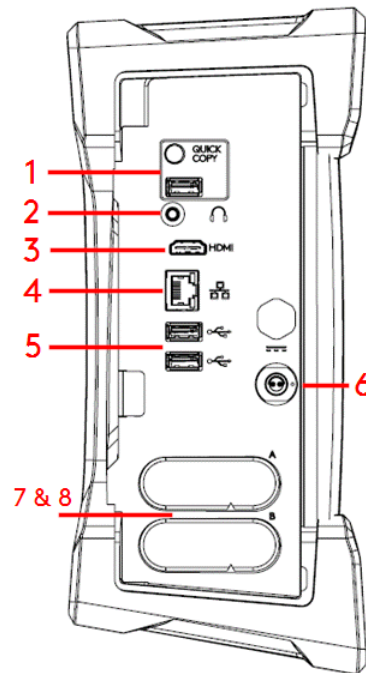

## 1. QUICK COPY

Use to transfer all your inspection data to a USB mass storage device and import data from the USB mass storage device's User Data folder.

## 2. AUDIO CONNECTOR

Use to plug a headset to the instrument.

## 3. HDMI® CONNECTOR

Use to connect an external monitor to the instrument.

## 4. NETWORK CONNECTOR

Use to connect the instrument to a local area network (LAN), also allowing remote RDAU operation. The connector is equipped with two indicators with the following behaviours:

a) Connection indicator (upper)

**Green:** Communication established with the network

**Blinking green:** Activity between the instrument and the network

**Unlit:** No link to the network

b) Connection speed indicator (lower)

**Amber:** Operating as a gigabit connection (1 Gbps)

**Green:** Operating as a 100 Mbps connection

**Off:** Operating as a 10 Mbps connection

## 5. USB 2.0 CONNECTORS

Use to connect USB devices to the instrument such as a mouse or an external keyboard. Can also be used for file transfer to USB storage device.

## 6. POWER CONNECTOR

Use the supplied power cord to operate the instrument and recharge its batteries.

## 7. BATTERY COMPARTMENTS

Insert the supplied batteries into the compartments. For details about batteries, see section 2.5 – 2.7.0

## 8. PROTECTIVE BATTERY COMPARTMENT DOOR

Protects the battery compartments from the elements.

## 2.3 Positioning Sonyks

The Sonyks instrument must be properly positioned prior to use so that you do not run the risk of dropping the instrument or the instrument falling over. The instrument has two safe operating positions: horizontal and tilted. To use it in a tilted position, simply pull out the stand located at the rear of the instrument until the instrument is at the desired angle. If you are using Sonyks instrument with the optional harness, see 2.8.1 Adjusting the Harness for details.

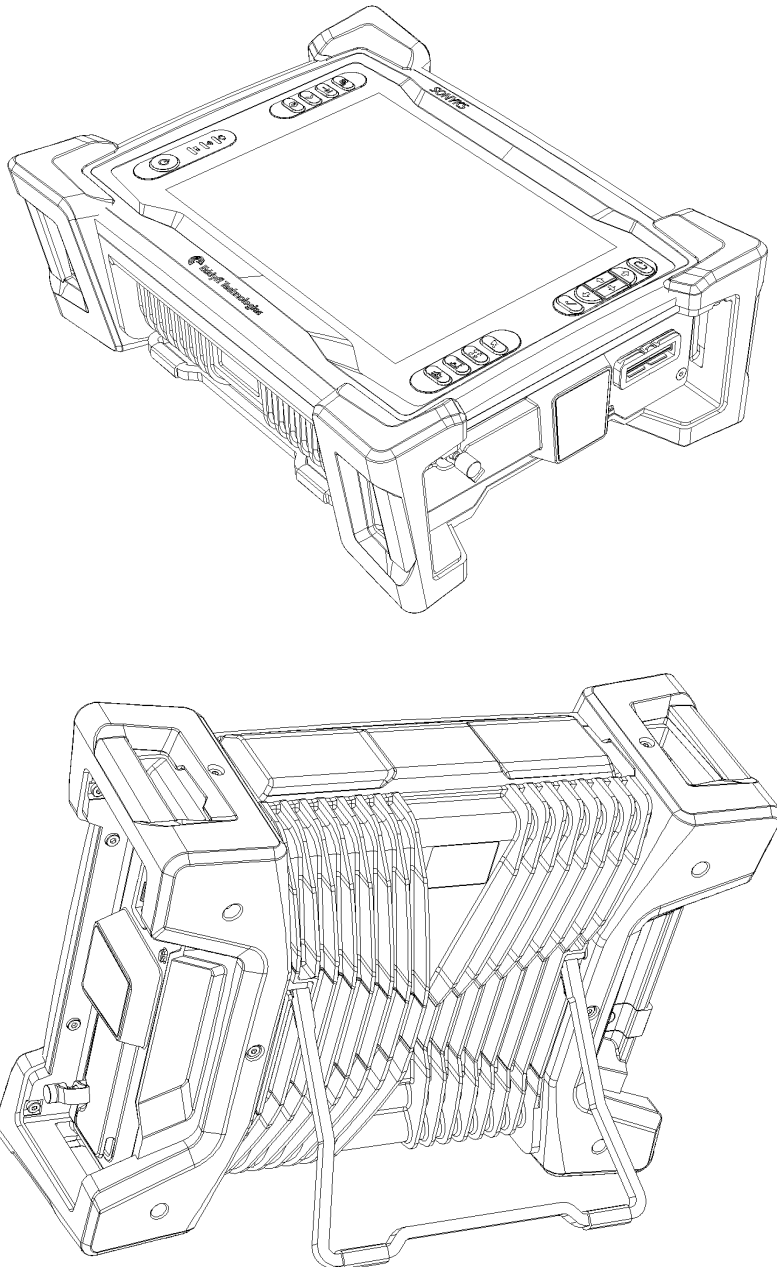

<p>CAUTION</p> 	<p>CAUTION</p> <p>It is possible to use the instrument whilst it rests on its lower bumpers, but this is not a safe operational position as the instrument may fall over. If you want to use it at an angle, use the stand located at the rear of the instrument.</p> <p>IMPORTANT</p> <p>Regardless of how you position the instrument, you must always have a minimum clearance of 10 cm (4 in) on all sides of the instrument. Always position the instrument away from heat sources. This ensures proper heat dissipation while the instrument is in use.</p>
--	---

## 2.4 Starting the Sonyks instrument

Proceed as follows to turn on your instrument or exit the standby mode:

- 1 Make sure that at least one of the two batteries is inserted into either of the battery compartments of the instrument or that the instrument is plugged in to an external power source using the supplied power cord.
- 2 Press the power button.
- 3 The power indicator at the centre of the power button lights green.

## 2.5 Batteries

The instrument can be used under battery power. The instrument is designed with two battery cradles under the protective battery compartment door but can be powered by a single battery. The instrument uses lithium-ion rechargeable batteries.

### 2.5.1 Inserting Batteries

- 1 On the left side of the instrument, unlatch the battery door to the battery compartment, and then open it.
- 2 Align your battery with one of the battery cradles.
- 3 Make sure that the battery contacts are facing inward and upward.
- 4 Slide the battery into the battery cradle until it is fully inserted. You should feel the battery contacts snap into place.

**NOTE:** Battery cradles are marked A and B. If you are inserting only one battery, it does not matter which of the two cradles you use.

### 2.5.2 Removing Batteries

- 1 On the left side of the instrument, unlatch the battery door to the battery compartment, and then open it.
- 2 Hold the battery tab between thumb and forefinger.
- 3 Pull on the tab.
- 4 You will feel the battery contacts being released.
- 5 Slide the battery out of its cradle.

### 2.5.3 Hot Swapping Batteries

You can remove one of the batteries when the instrument is turned on as the software can operate with a single battery. Should the power in the remaining battery be insufficient to keep the instrument operating, it will shut down without damaging electronic components, but any work in progress may be lost.

## 2.6 Optional Battery Charger

An optional battery charger is available from Eddyfi. Contact your Eddyfi representative for more information about pricing and availability. This charger conditions and calibrates the instrument's batteries, which is important to maximize their lives. It is recommended that the batteries are calibrated every six months.

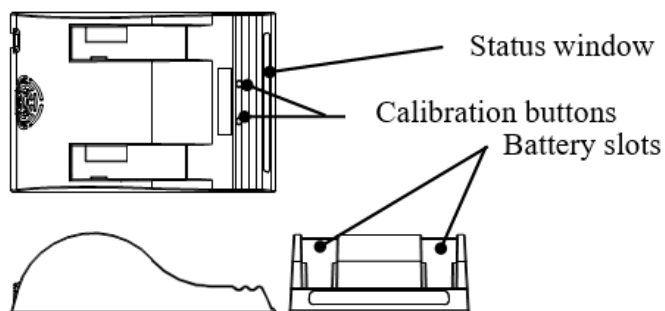

### 2.6.1 Charging Batteries

To charge the batteries with the optional charger:

- 1 Place the charger on a flat and level surface, away from heat and moisture sources.
- 2 Insert the DC connector for the power supply into the back of the external charger.
- 3 Connect the power supply to an AC supply using the supplied cable. All the LEDs flash momentarily to let you know that power is present.
- 4 Insert the batteries into the battery slots making sure that the contacts are fully seated.
- 5 The charger automatically begins charging the batteries and the LEDs in the status window display the following information:
  - **Blinking green:** Battery charging
  - **Green:** Battery fully charged
  - **Blinking blue:** Battery calibrating
  - **Blue:** Battery charge gauge calibrated
  - **Blinking red:** Battery charge gauge in need of calibration
  - **Red:** Error

### 2.6.2 Calibrating Batteries

To ensure that your batteries perform at their full capacity for the longest possible time, it is important to calibrate them on a regular basis. Calibration involves a standard battery charge followed by a deep discharge, and then a complete charge. This procedure usually takes 10 to 13 hours, whereas a standard charge only takes approximately 3.5 hours.

Calibrate batteries by placing them in the optional charger and then pressing the calibration button. It is recommended that the batteries are calibrated every six months.

## 2.7 Storing Batteries

Whenever transporting the Sonyks in its case, remove the batteries from the instrument, place them in plastic bags, and then make sure that they cannot come in contact during transport, as this is a significant fire and explosion hazard. The transport case is outfitted with two slots intended for the batteries and it is recommended that they are used.

## 2.8 Optional Harness

Harnessing Sonyks requires several specific adjustments so that you feel comfortable wearing the harness and that the system is operated safely in this configuration.

### 2.8.1 Adjusting the Harness to your Body

1. Hold the harness shoulder straps and slip it over your shoulders as you would a jacket.



2. Verify the fit of the harness. Visualize working with Sonyks before making any adjustments to the shoulder straps and height of the belt.
3. Remove the harness.
4. Use the underarm straps and shoulder blade rings to adjust the fit of your shoulder straps. You may need to perform this adjustment several times to get the proper fit.





5. Use the back and side belt straps to adjust the height of the belt on the harness to suit your body type. You may need to perform this adjustment several times to get the proper fit.

**NOTE:** Your belt's height determines the lowest position of instrument. Adjust this height so that the display of the instrument is easy to see for that, the belt could end up higher than your hips.



6. Once your belt and shoulder straps are adjusted, clip and tighten the chest straps.



7. Secure the belt around your waist, according to the height you have adjusted it.



8. Make sure that the harness is close-fitting.
9. Make sure that the shoulder anchor straps on the harness are loose.



10. Unfasten the two straps at each end of the shoulder anchor straps. Place them within hands reach. You will need them.

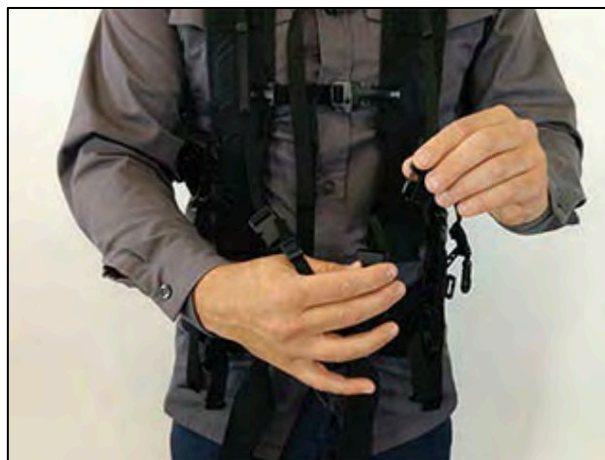

11. Sit down.

12. Place Sonyks horizontally in your lap.

13. Slip the looped portion of the strap removed above in the hook of one of the two upper Sonyks bumpers, as illustrated.

**NOTE:** Illustrated here is the Reddy instrument, but harness adjustments on Sonyks are the same.



14. Slip the clip through the strap hoop, and then pull to tighten into place, as illustrated above.



15. Repeat the previous two steps for the opposite upper bumper.

**NOTE:** You can also secure the straps to the bumpers in a more elegant and less easy-to-remove fashion, as illustrated here.



16. Locate the anchor strap on the harness's belt.



17. Open the battery compartment door and slip the male buckle of the anchor strap, as illustrated.



18. Mate the male buckle to its female counterpart.





19. Close and secure the battery compartment door.



20. Repeat the procedure for the opposite belt anchor strap.

21. Adjust the length of the anchor straps until comfortable.

22. Mate the left male buckle of the shoulder anchor strap to its female counterpart.



23. Repeat for the opposite shoulder anchor strap.

24. Tighten each shoulder anchor straps to achieve the desired view angle for Sonyks.



**NOTE:** Use the belt strap to hook your tool lead and air hose.



Chapter 3

# Introducing the Sonyks Software

## 3. Introducing the Sonyks Software

The Sonyks Software runs the latest version of Eddyfi Technologies' data collection and analysis software for Guided Wave Testing. There are two types of software available; Sonyks GO which is installed on the Sonyks Instrument (embedded) and Sonyks PRO which can be installed on a laptop (PC). The software is split into the frontstage and backstage. The frontstage is used to collect and analyse GWT data. The backstage is primarily used to enter project details, manage system settings and files. The software opens on the backstage.

### 3.1 Project Based Inspection

The Sonyks software is project based. This means that an entire inspection project can be handled in a single file. Each project file will contain the data, analysis and reports of each and every test conducted within that project.

#### 3.1.1 Project construction tree:

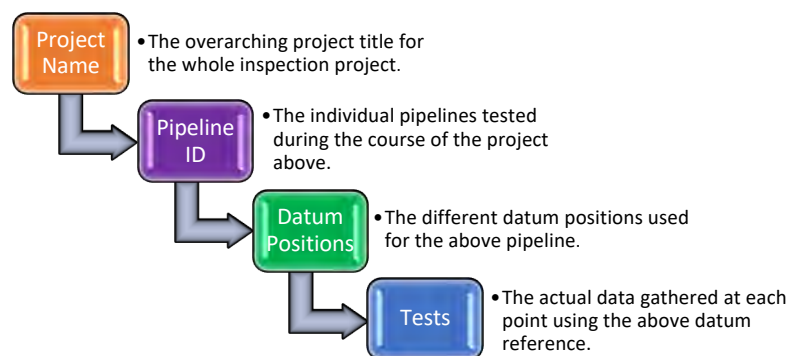

Example:

- GWT Inspection of Refinery
  - Crude Oil Inlet
    - Datum 1 – Flange on Tank 101
      - Test Location 1
      - Test Location 2
      - Test Location 3
    - Datum 2 – Weld on south side of road crossing
      - Test Location 4
      - Test Location 5
  - Condensate Line
    - Datum 1 – Flange on condenser
      - Test Location 1
      - Test Location 2
      - Test Location 3



- H2S Line
  - Datum 1 – Flare stack
    - Test Location 1
    - Test Location 2
    - Test Location 2 - reshoot

### 3.1.2 Advanced Post Processing

Post-process frequency extraction enables all test frequencies to be accessed. Focusing may now be performed at any point and at any time ensuring that the opportunity for further, more detailed interrogation is never missed.

## 3.2 Installation

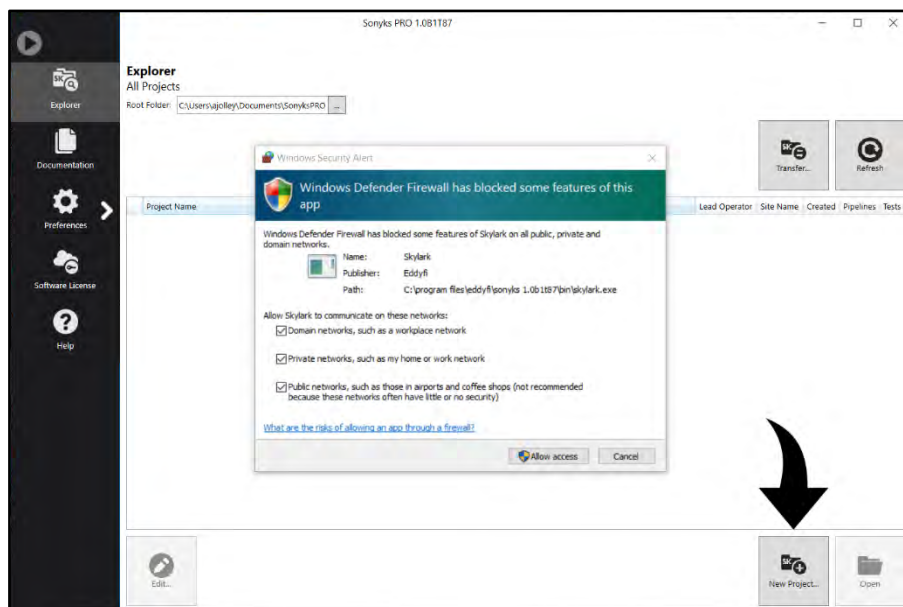

Ensure all three boxes are checked and click Allow access (needed for RDAU mode access).

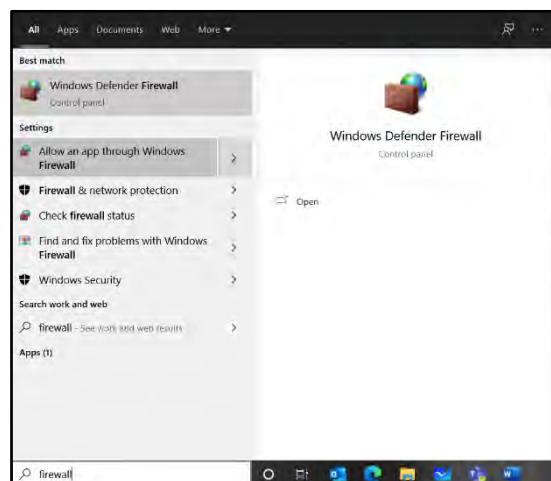

If this is not done during installation, type 'firewall' into the windows search box on the task bar and select 'Allow an app through Windows **Firewall**' option.

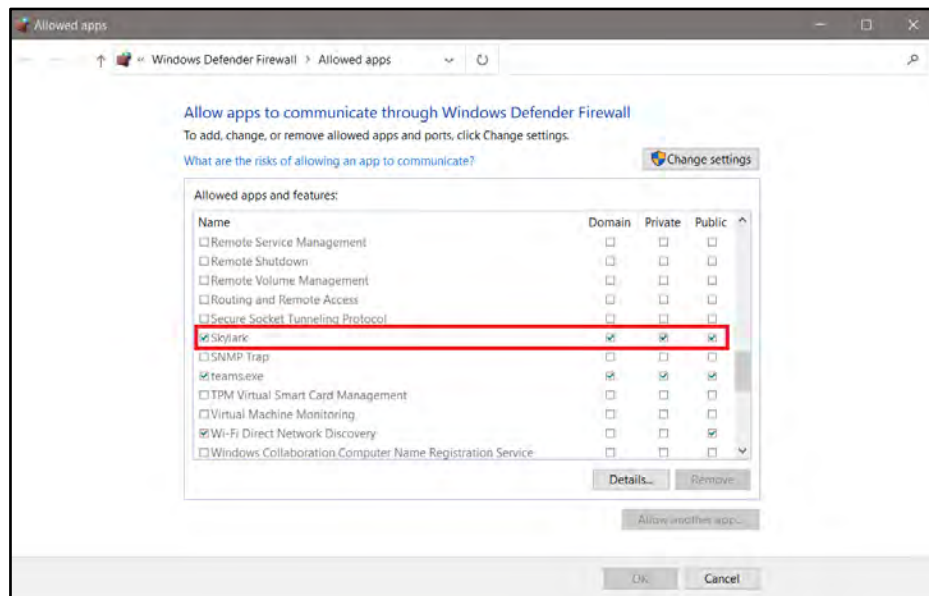

Scroll down to find Sonyks (Sonyks PRO) and ensure that all three boxes are checked. Click OK to exit.

### 3.3 Backstage

#### 3.3.1 Explorer

The Explorer menu option allows Virtual users to browse, create and open previous projects. Data (whole or partial projects) can also be transferred to and from external media devices, such as USB keys.

It is also where new projects will be created.

The default folder (Sonyks PRO) is `C:\Users\username\Documents\Sonyks` – which is created when the software is installed. The explorer can be directed to other Windows folders if required. If the root directory is changed then the explorer view will need to be refreshed using the Refresh button.

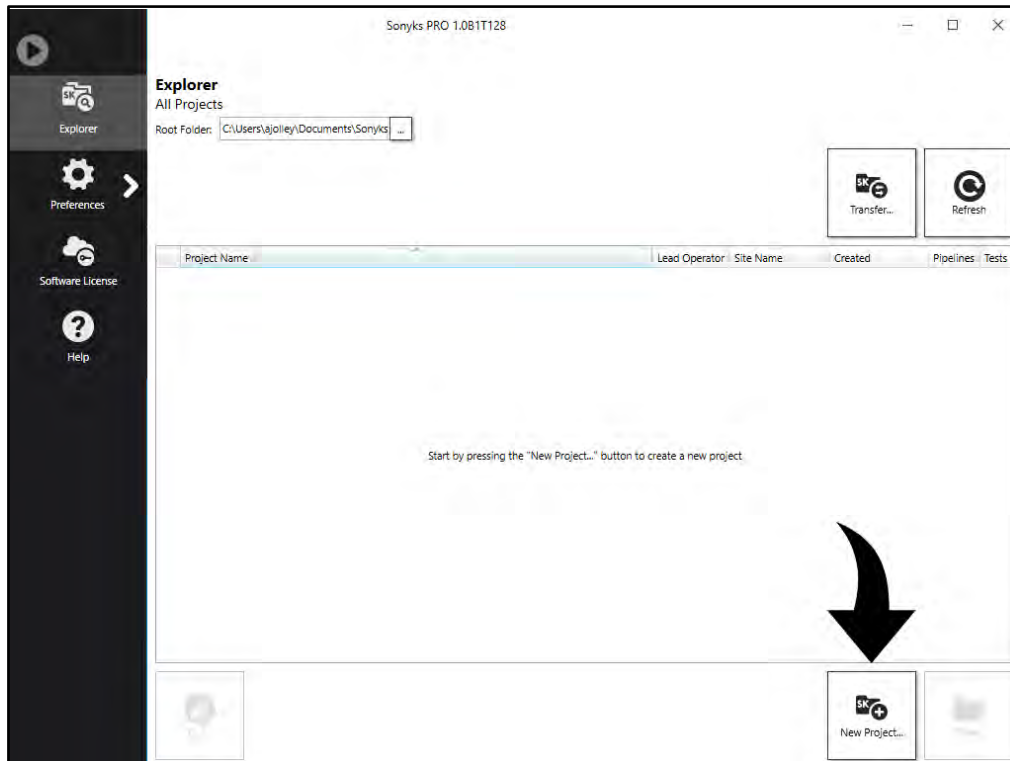

### 3.3.2 Transferring Data

By default, the software will automatically look on the D:\ drive for data to transfer. If more than one USB drive is detected, you will be asked to specify the path to use.

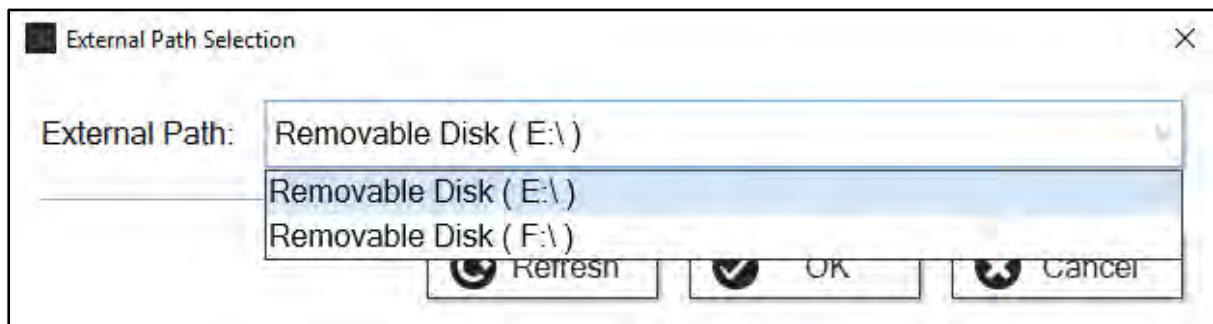

In the data transfer menu, whole projects can be copied, parts of projects can be copied or just a single test can be copied.

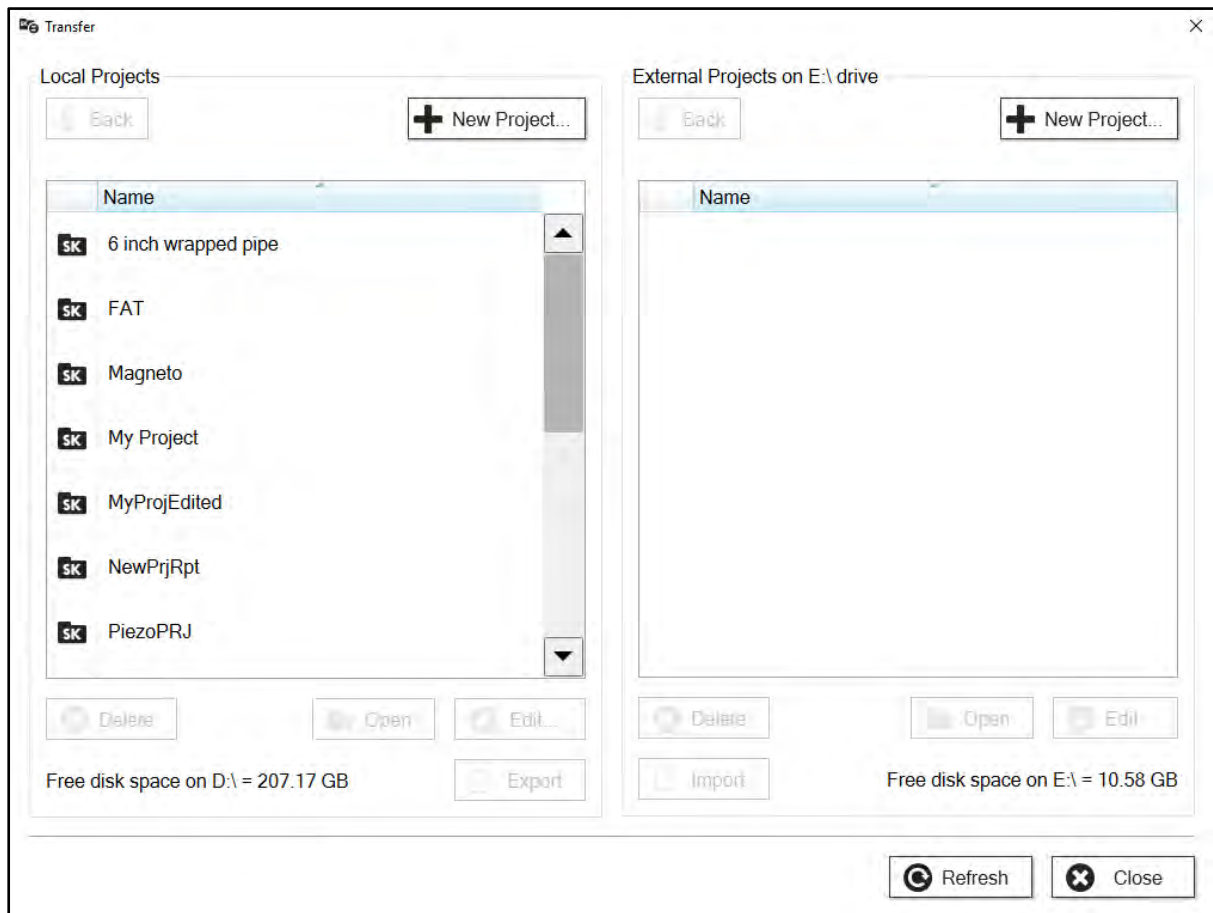

Select the Project you wish to export. Clicking the **Export** (or **Import**) button will copy the entire project. Clicking **Open** will open the project to show the list of Pipelines tested.

Select the Pipeline(s) you wish to export. Clicking the **Export** (or **Import**) button will copy all the tests on that pipeline. Clicking Open will open the Pipeline to show the list of Datum positions used on that pipeline.

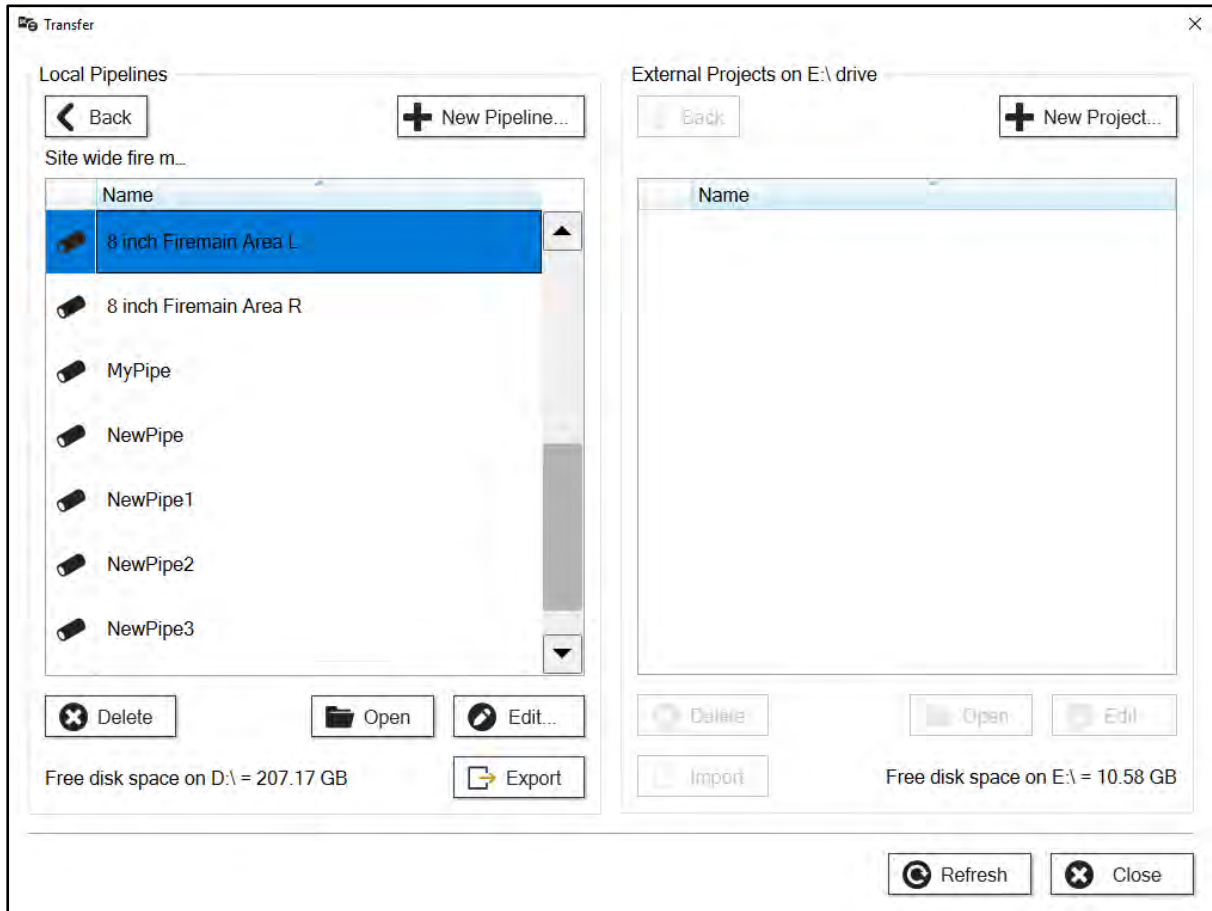

Select the Datum(s) you wish to export. Clicking the **Export** (or **Import**) button will copy all the tests that use the selected Datum position. Clicking **Open** will open the Datum to show the list of Tests conducted using the selected Datum position.

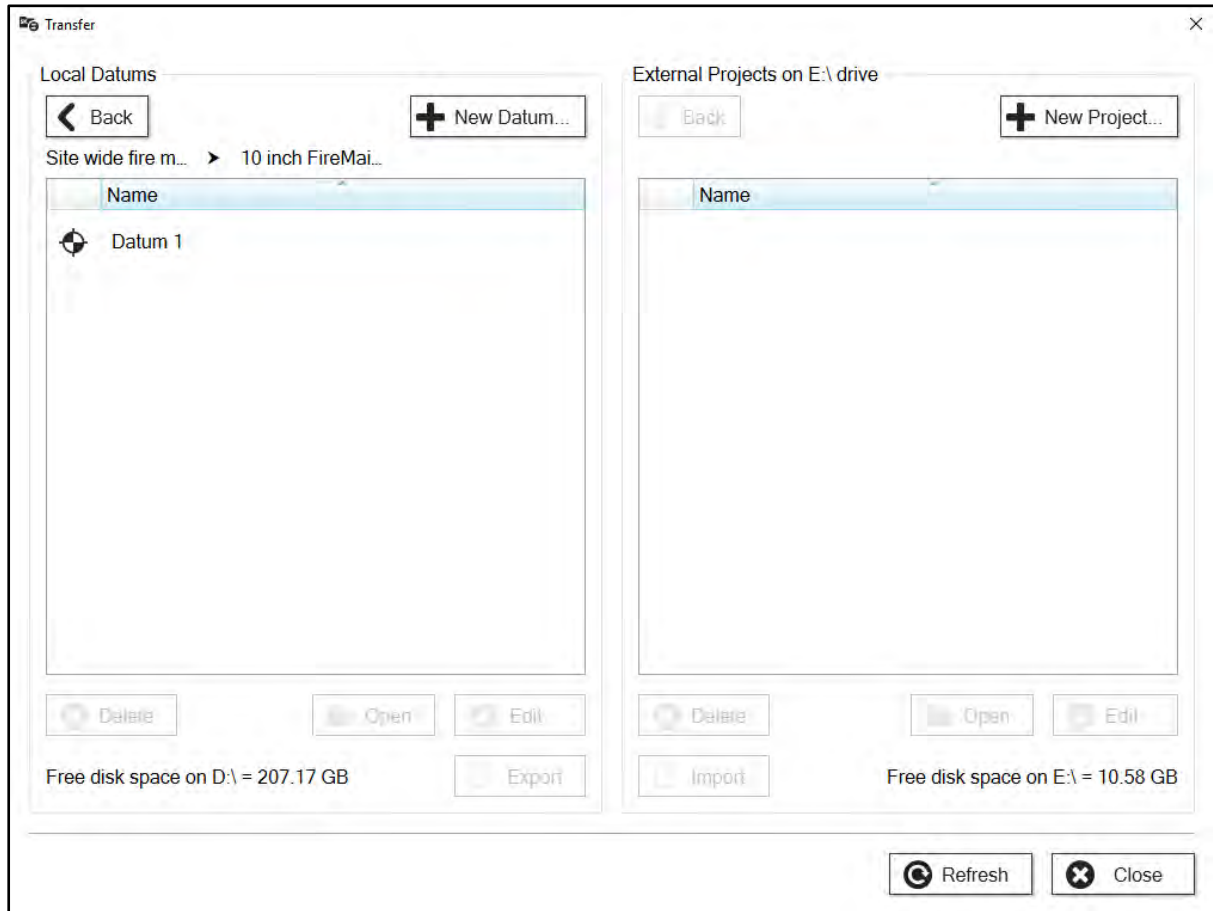

Select the Test(s) you wish to export. Clicking the **Export** (or **Import**) button will the tests.

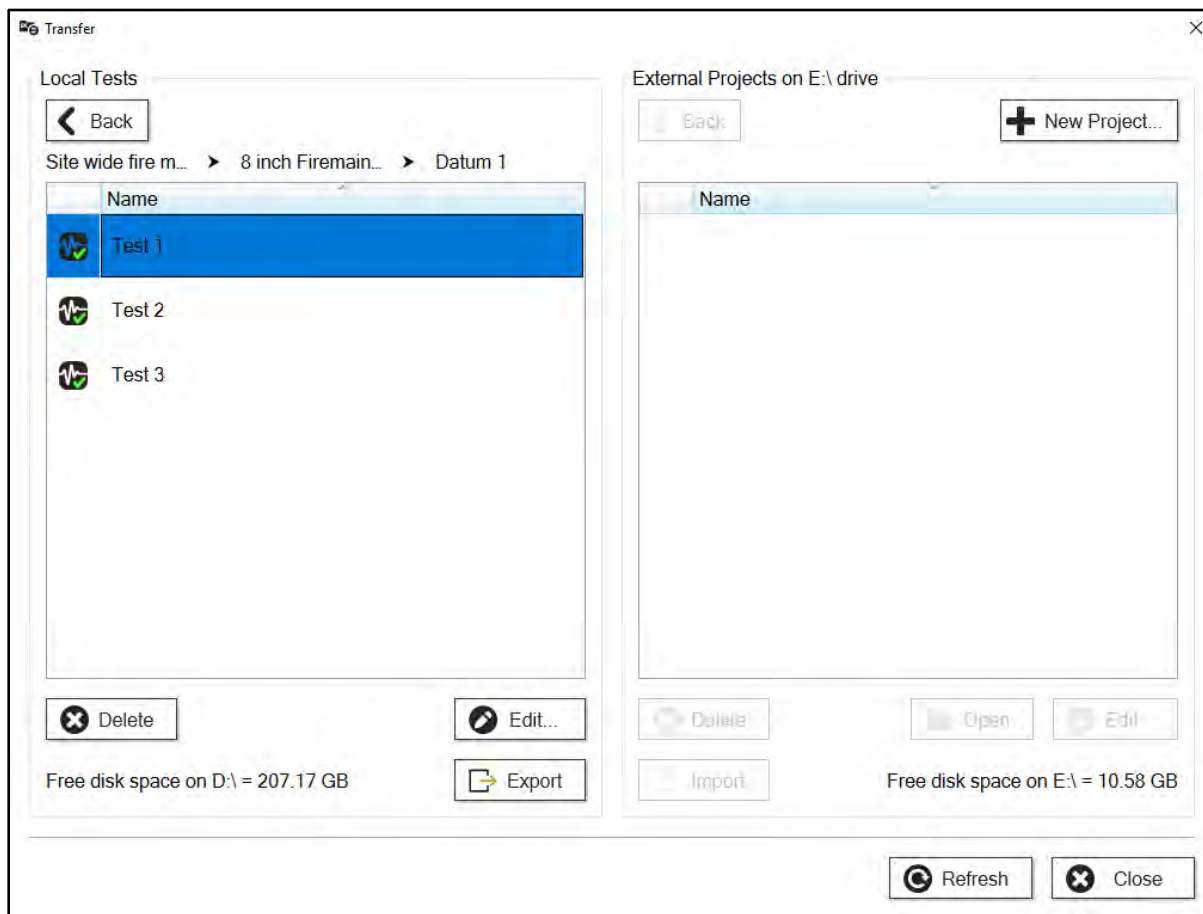

### 3.3.3 Preferences

In Sonyks PRO (PC version), the only available options are for measurement settings (imperial or metric) and a company logo can be uploaded for reporting purposes.

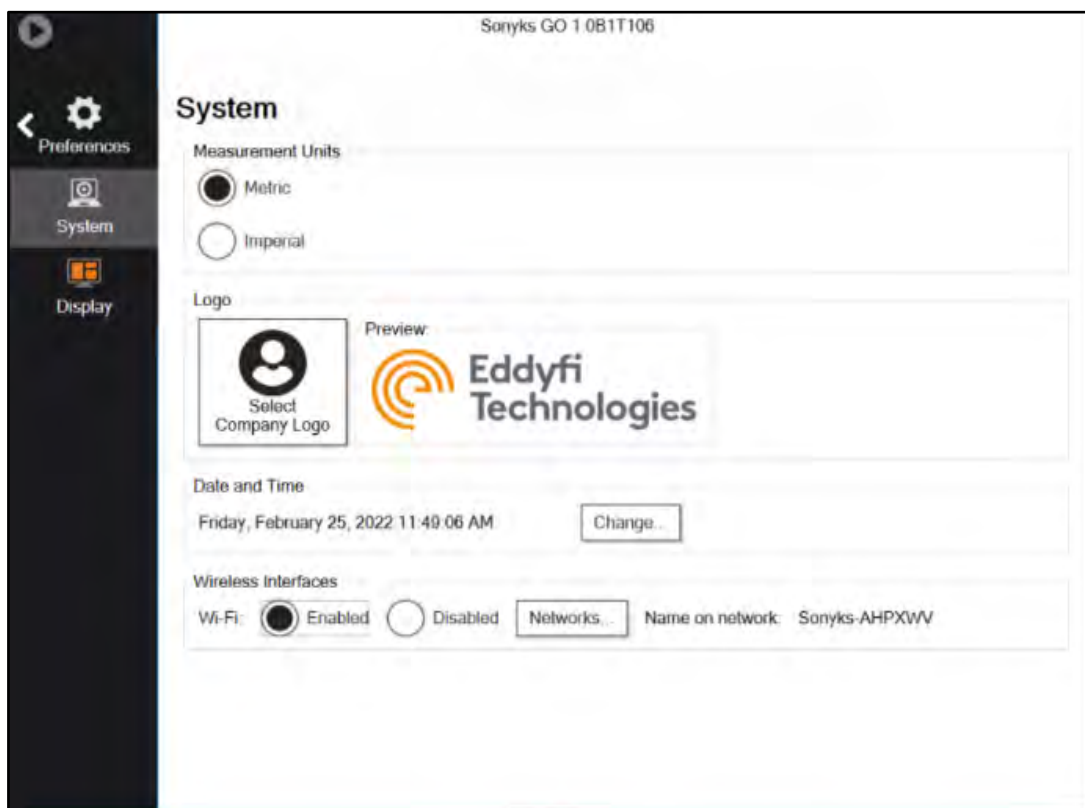

In the Sonyks GO (embedded version) there are also settings for the wireless connection, screen brightness and screen saver timeouts.

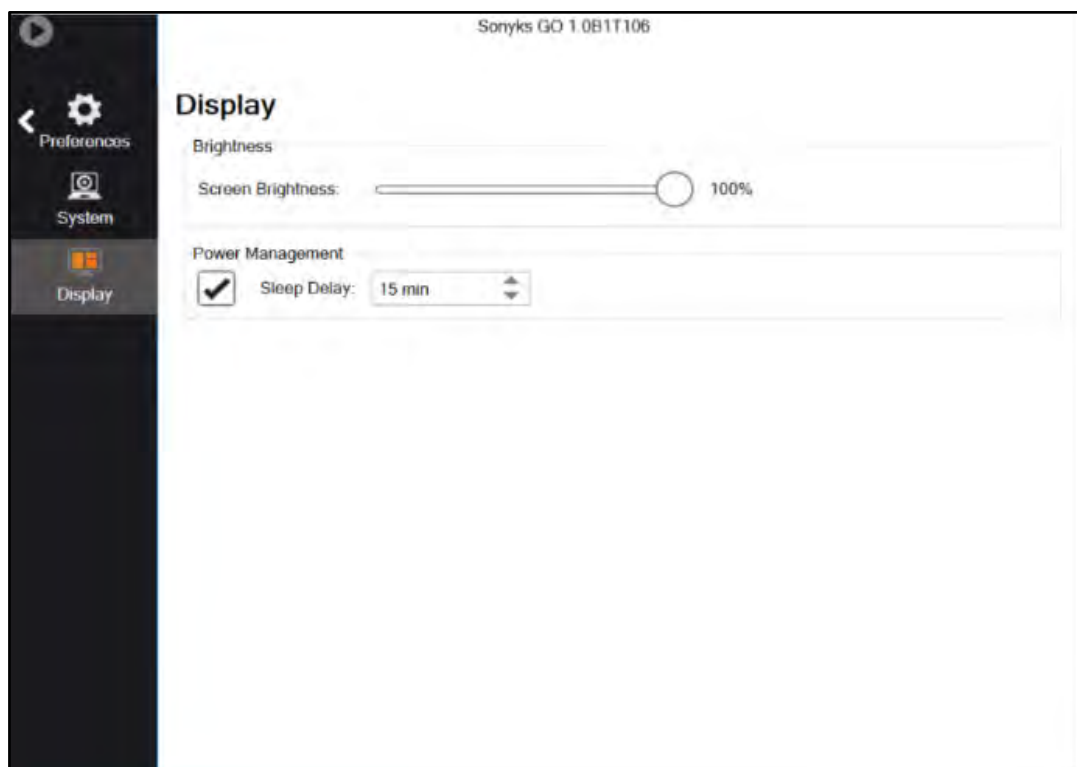



### 3.3.4 Software License

In the Sonyks GO (embedded version) the status of the license can be viewed here along with the license code and computer ID. Contact information can also be added.

In the Sonyks PRO (PC Version) there is an additional option to manage the license. The license can be released from the PC and used on another PC. For this to function correctly, both machines will need an internet connection.

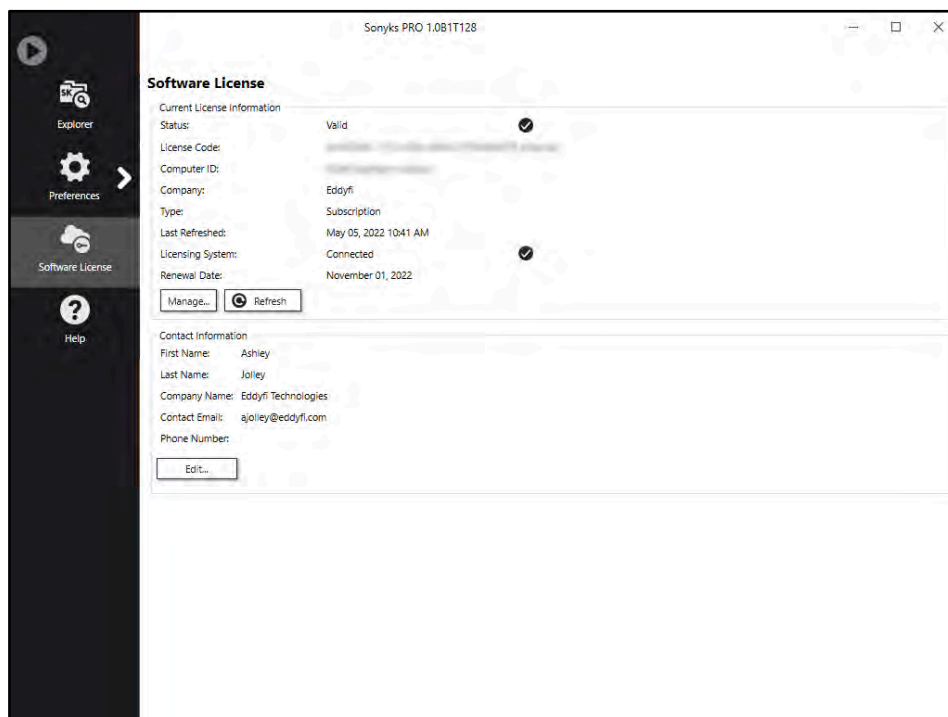

A warning will be displayed in the Explorer section of the backstage 60 days prior to the license expiration date.

For specific details regarding your licensing agreement, contact your Eddyfi representative.

### 3.3.5 Help

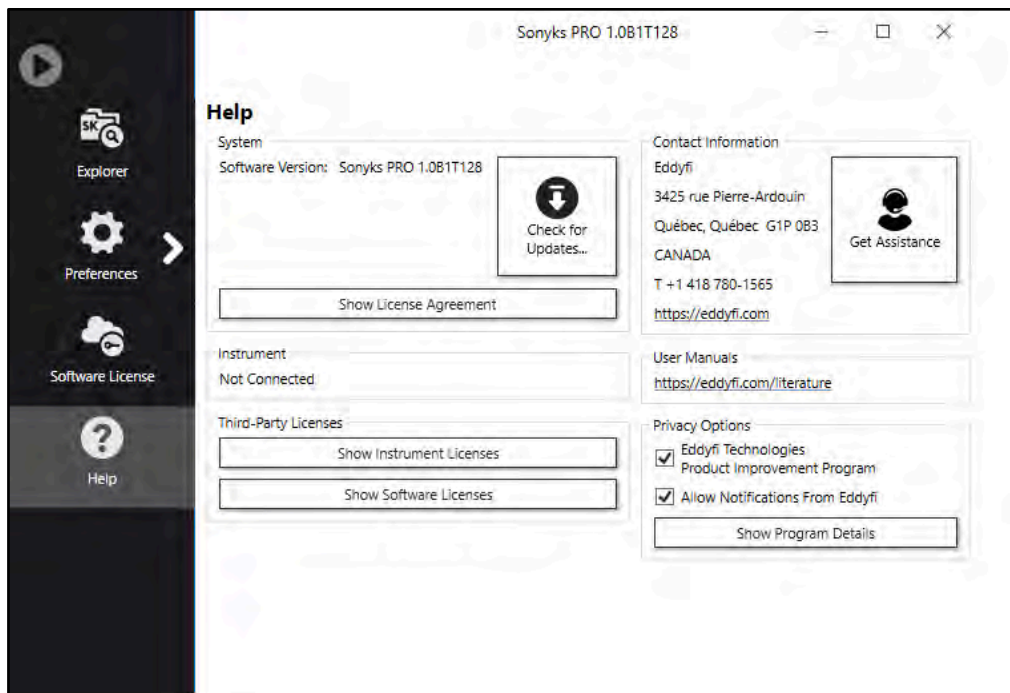

The help screen will enable you check for updates and save log files of the data that has been acquired.

### 3.3.6 Get Assistance

The **Get Assistance** feature can be found in the **Help** menu on the backstage. It can be used in the event of a system or software malfunction to isolate the cause of the malfunction.

Clicking on the **Get Assistance** button opens the window shown below. After accepting the Terms of Use, two options will become available to you.

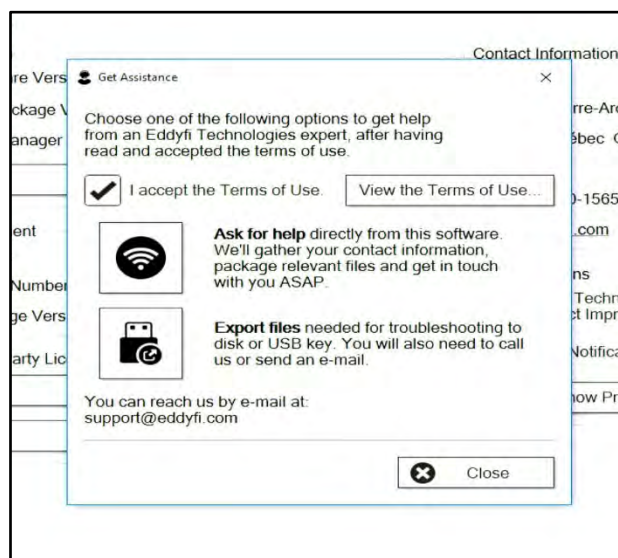

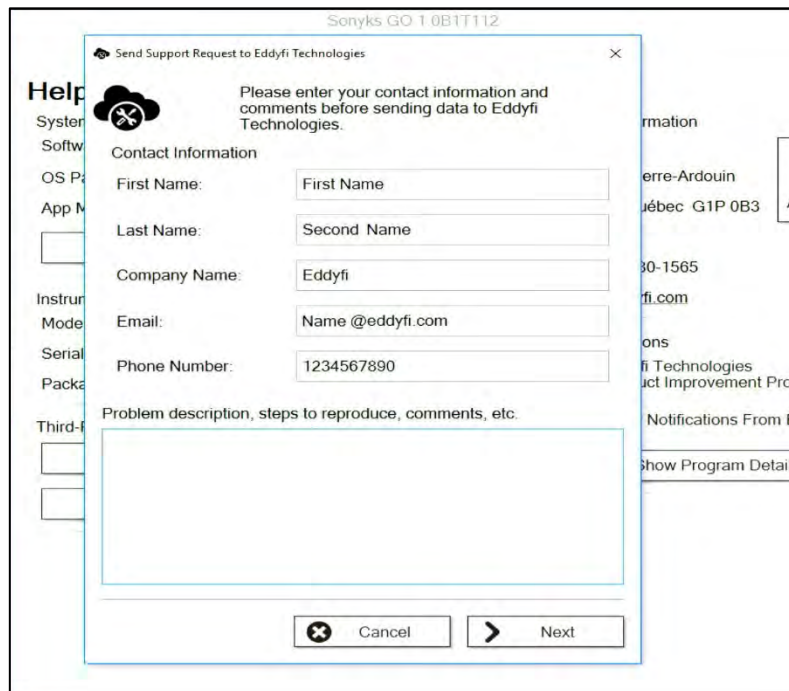

If a connection to the internet is available, you may use the **Get Assistance** feature. Enter your contact details in the fields provided.

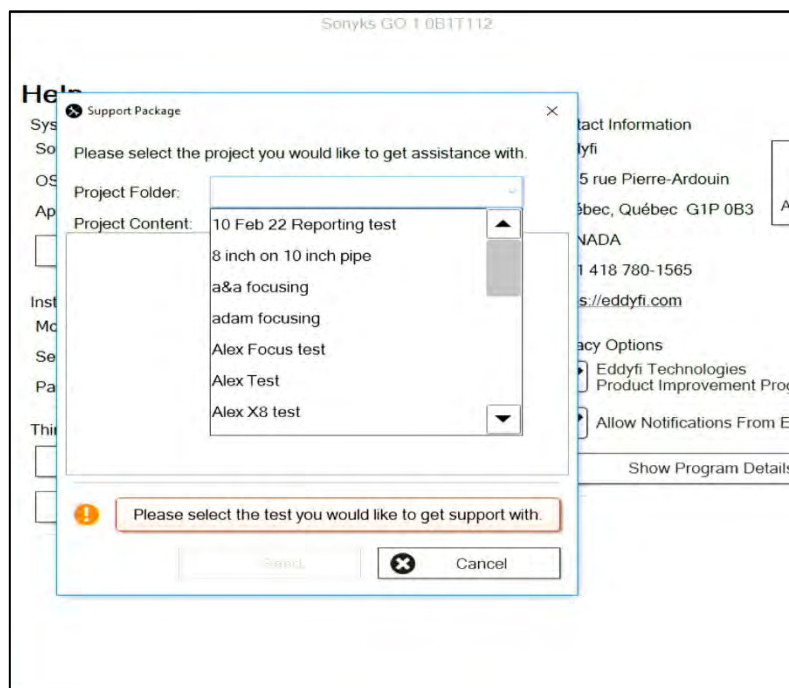

Select the appropriate project folder.

Then select the appropriate test file. Pressing the **Send** button will automatically send the relevant logs and information to the Eddyfi support team. The support team will then contact you ASAP.

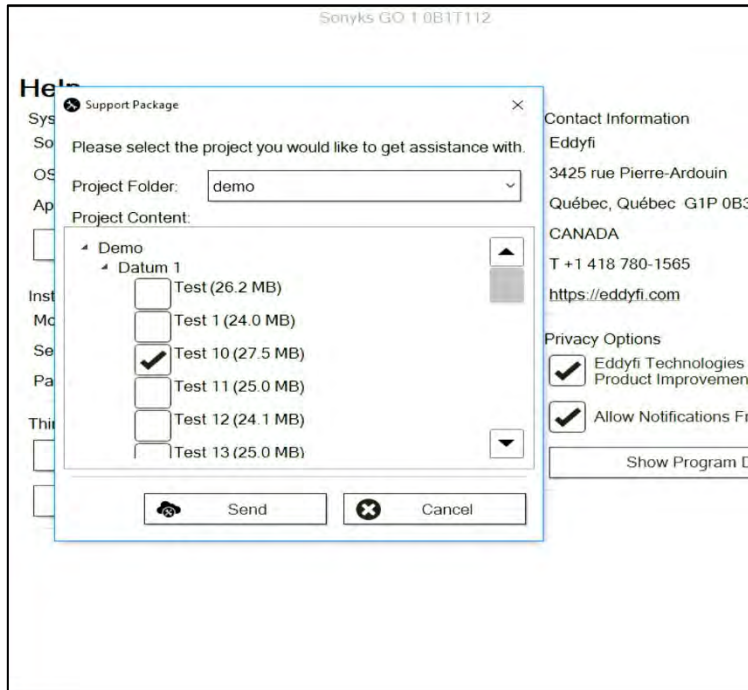

Alternatively, if no internet connection is available the logs and files can be exported to a USB drive and attached to an email (send to: [support@eddfi.com](mailto:support@eddfi.com)) using the **Export files** feature.

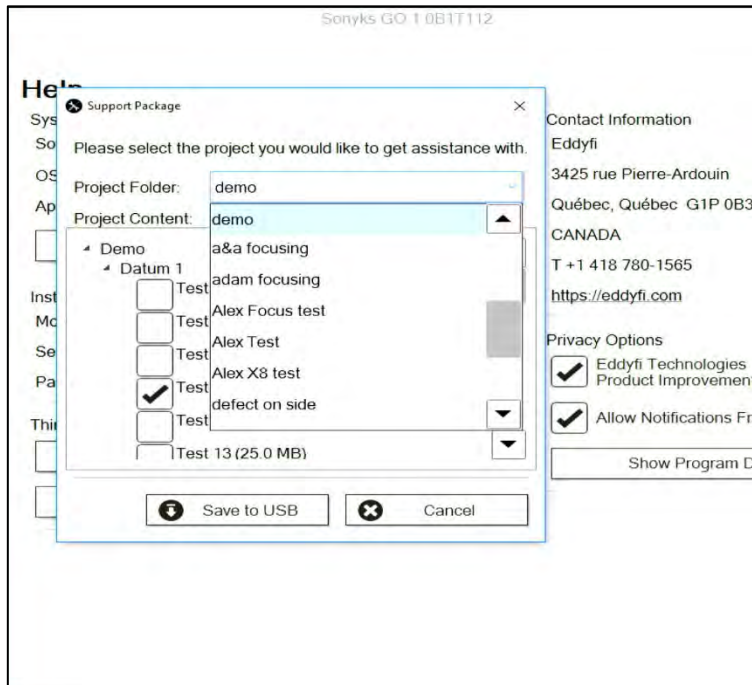

Select the relevant project folder and test file. Clicking on **Save to USB** will export the necessary test and log files to the attached USB drive.

### 3.4 Creating a Project

In the Explorer tab on the backstage, click on the **New Project** button to create a new project.

The screenshot shows a 'Project' dialog box with the following fields and values:

- Project Name:** Pipe Rack Inspection
- Site:** Eddyfi Cambridge
- Client:** Eddyfi Technologies
- Lead Operator:** A. N. Other
- Project Summary:** Some details about the project.  
Inspection of five pipelines on rack 1.
- Procedure:** QAS-GWT-001

Buttons at the bottom right: OK, Cancel.

Here the Project can be named, along with the site at which the project is to be carried out and the clients name.

The Lead Operator is the technician responsible for the whole project. There are entry fields later for the name of the technician(s) who conduct the tests.

The project summary can be used to record additional details regarding the inspection.

The procedure number can also be recorded.

Click **OK** to continue.

### 3.5 Creating a Test

If using the Sonyks PRO (PC version) the PC will first need to be connected to an instrument in RDAU mode to start a test.

If using the Sonyks GO (Embedded version), continue to 3.5.2.

#### 3.5.1 Connecting an Instrument (RDAU mode)

Remote Data Acquisition Unit (RDAU) mode allows the unit to be controlled by a laptop or PC. To start the unit in RDAU mode, press and hold the power button until the warning indicator flashes red. Connect the unit to the laptop with an ethernet cable.

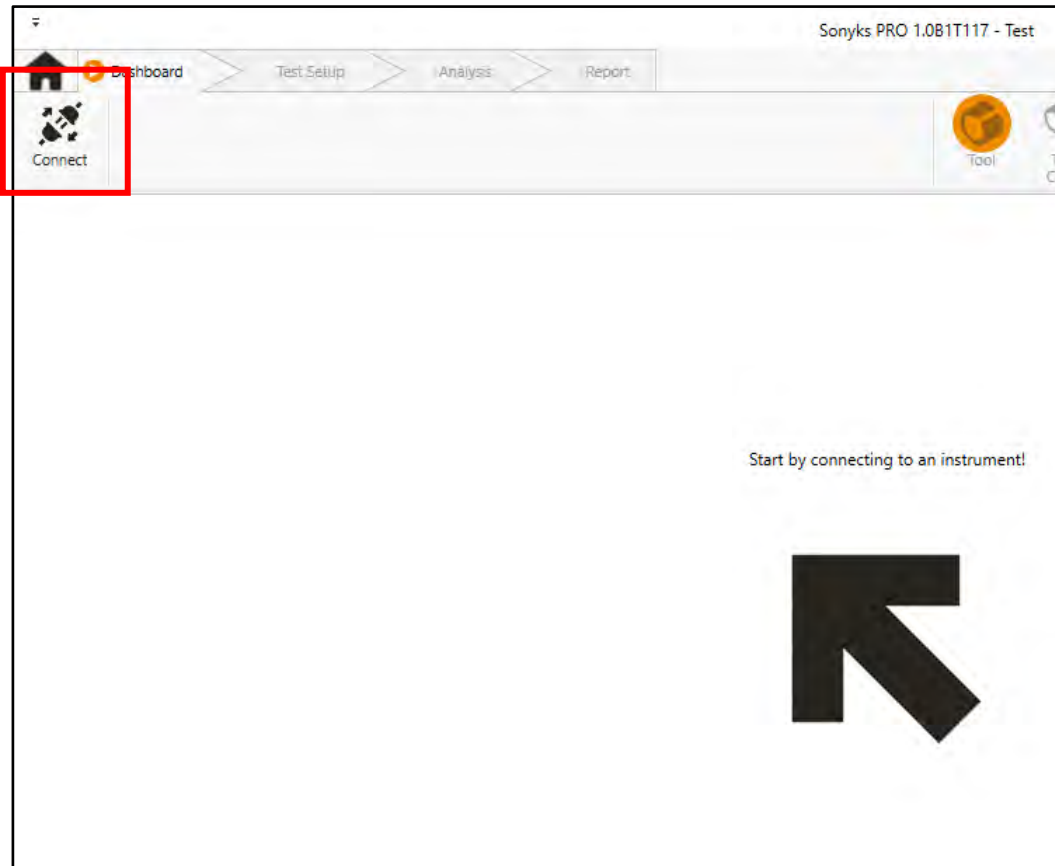

Open the software and click the **Connect** button.

Select the unit and click **Connect**.

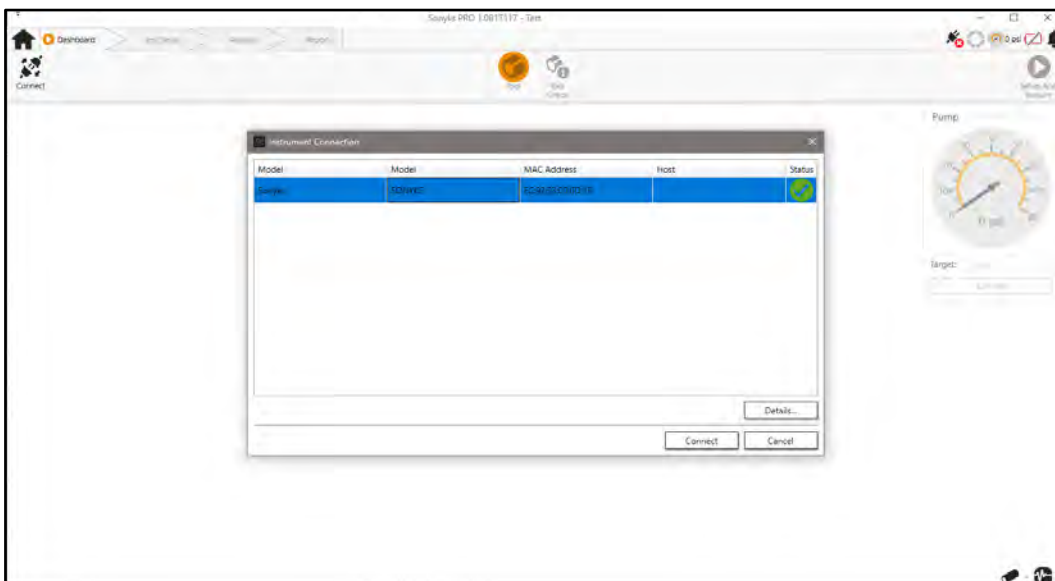

### 3.5.2 Dashboard

Here you can set tool details, run a tool check, set the pressure, and set the test range.

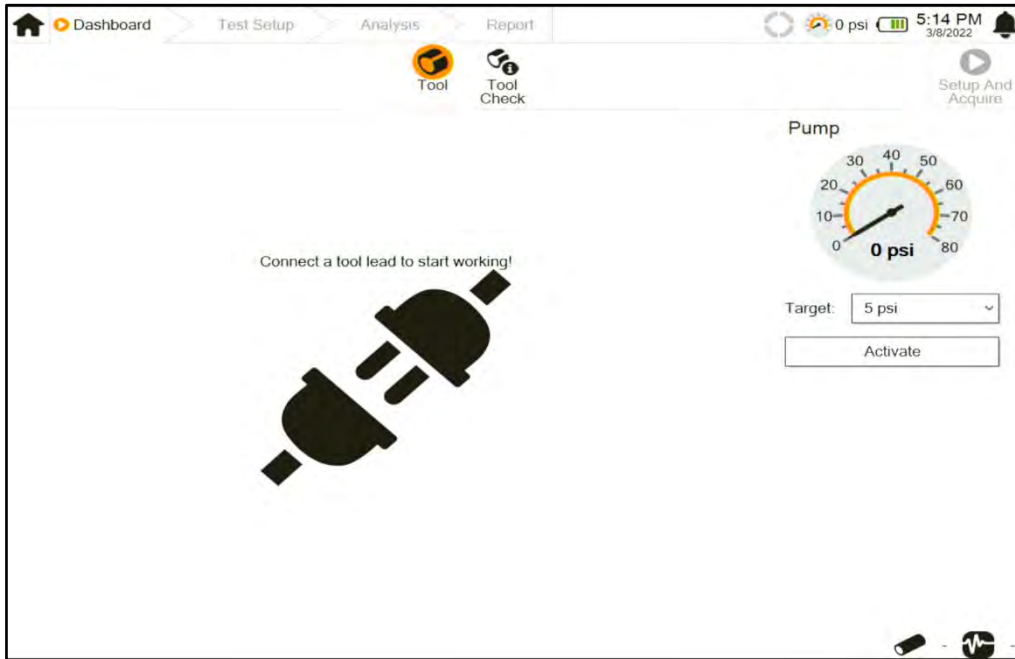

Connect a tool lead to start working. For all tooling options the tool lead type will be automatically detected upon connection.

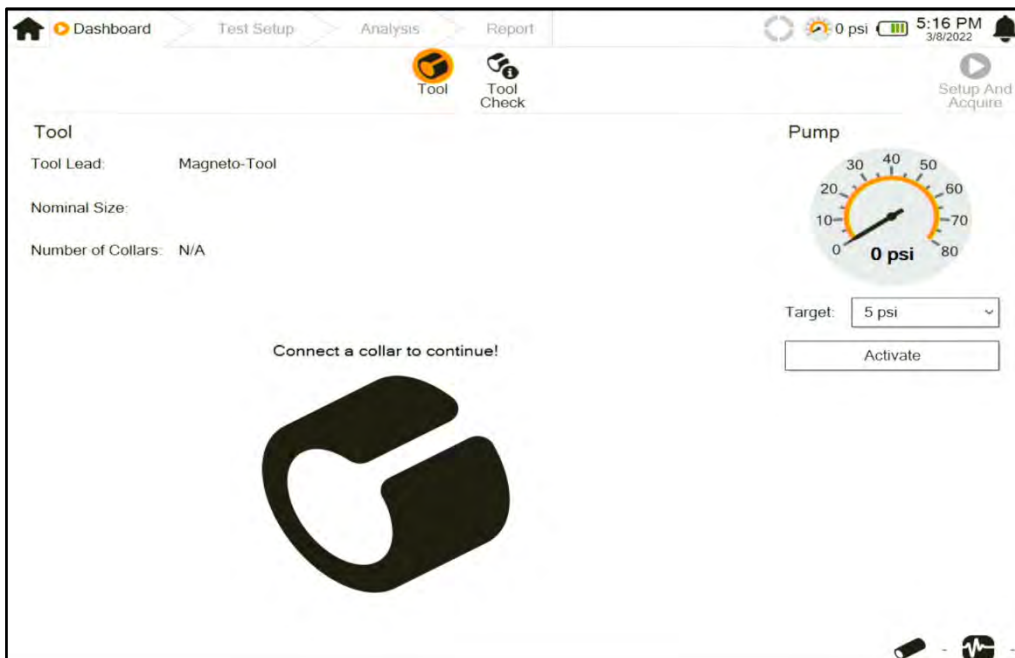

The software has recognised that this is a tool lead for a Magneto-Tool and will wait for the connection to be made to the tool.



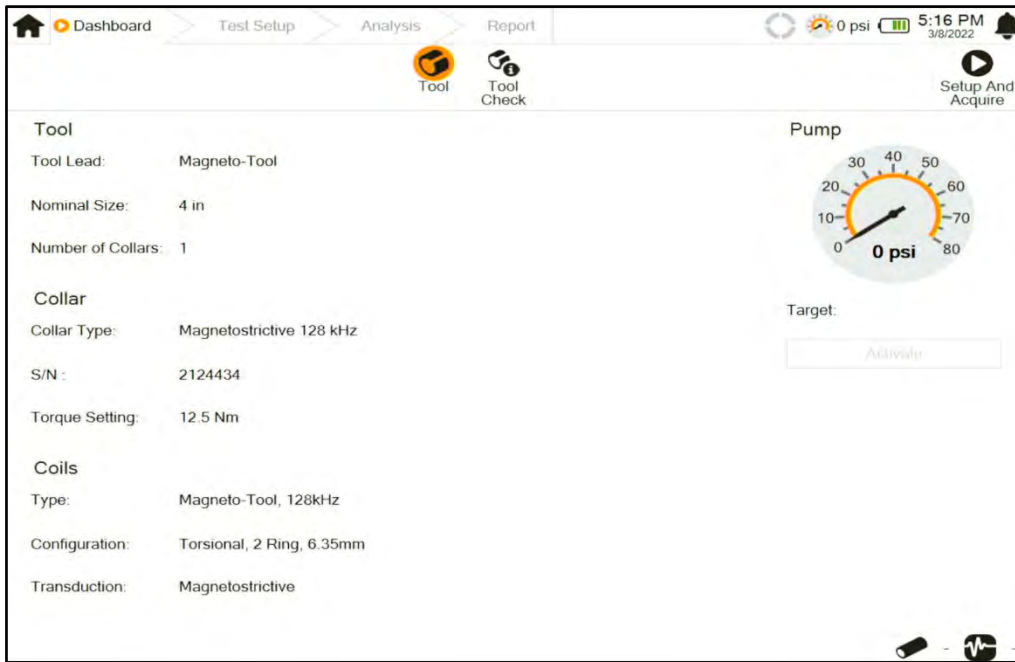

For both Piezo-Tools and Magneto-Tools, the tool type and configuration will be automatically detected.

**NOTE:** The pump control has been disabled here as the magneto-tool shown does not require it.

For a Series 3 tool lead, no collar information can be obtained so this will need to be entered manually.

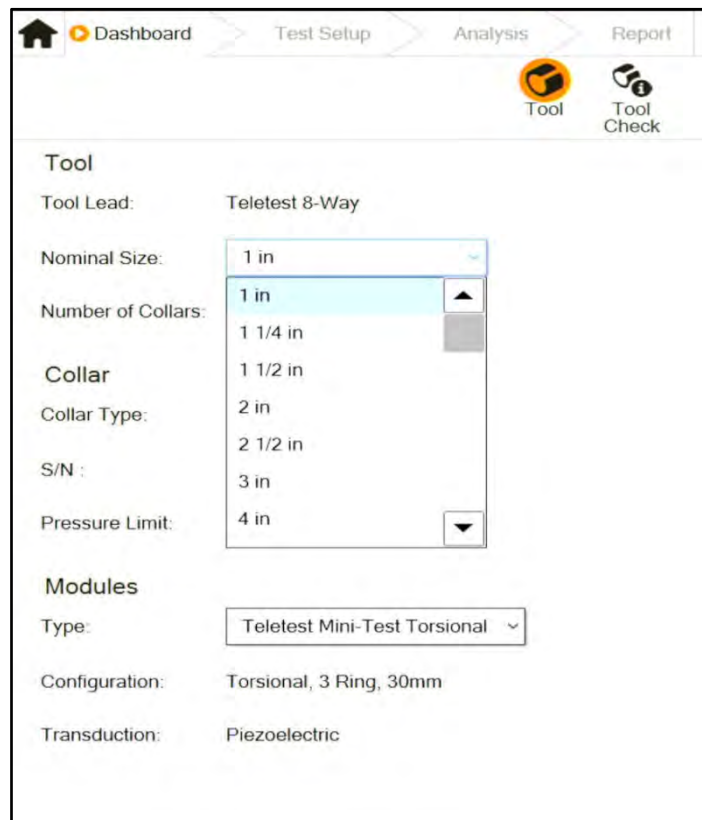



Set the tool diameter from the drop-down list.

- Select which type of modules will be used in the collar.
- The type of modules available will depend on the collar size selected.
- For 4in and below, the option will be mini-test modules. For 6in and above, the options will be Multimode 30mm, Multimode 46mm or Five Ring Torsional modules.

Tool	
Tool Lead:	Teletest 8-Way
Nominal Size:	8 in <input type="button" value="v"/>
Number of Collars:	1

Collar	
Collar Type:	Series 3
	<input type="text" value="Serial Number"/>
Pressure Limit:	60 psi

Modules	
Type:	Teletest 5-Ring Torsional <input type="button" value="v"/>
Configuration:	Torsional, 3 Ring, 30mm <input type="button" value="v"/>
Transduction:	Torsional, 3 Ring, 30mm Torsional, 3 Ring, 45mm

### 3.5.3 Tool Check

The tool check will run a capacitance for piezo-electric tools and a resistance test for magneto-strictive tools.

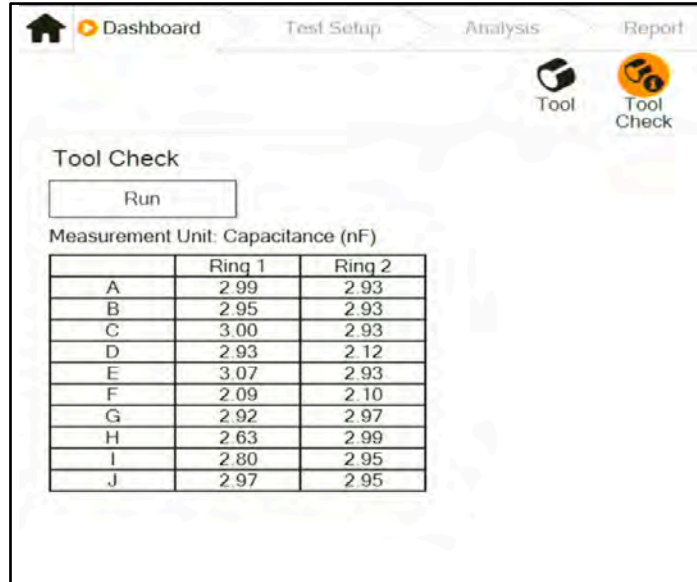

The tool check will automatically run at the start of every acquisition but can also be activated manually.

### 3.5.4 Pump Control

The target pressure will be set automatically for the tool type connected. The operator maintains the ability to adjust the pressure from the drop-down menu. The 5psi option is intended for use on vertical lines where it may be necessary for the tool to hold itself in place without being fully inflated.

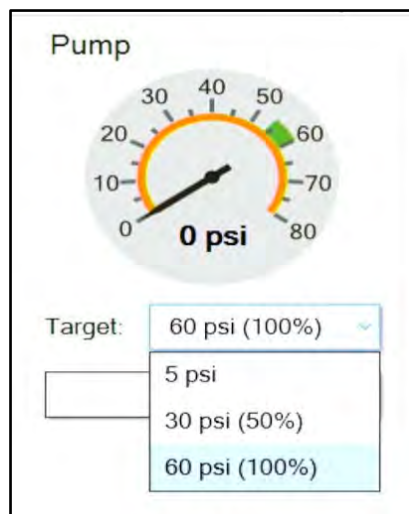

Once the pressure has been set, the pump can be activated (or deactivated) from the button beneath the Target dropdown box. Once activated, the pump will monitor and maintain the selected pressure in the collar during data collection.

### 3.5.5 Test Setup

This is where the test details can be entered.

For new projects a pipeline can be added by clicking the **New** button and entering the pipeline identification. This identification will be remembered for subsequent tests.

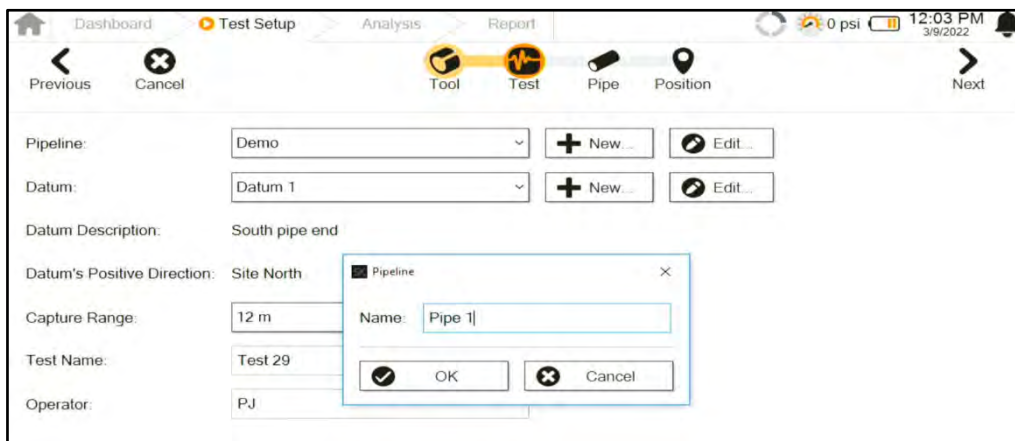

The screenshot displays the 'Test Setup' screen of the Sonyks Software. The interface includes a top navigation bar with 'Dashboard', 'Test Setup', 'Analysis', and 'Report' tabs. Below the navigation bar are icons for 'Previous', 'Cancel', 'Tool', 'Test', 'Pipe', and 'Position', along with a 'Next' button. The main form contains the following fields and controls:

- Pipeline:** A dropdown menu showing 'Demo', with '+ New...' and 'Edit...' buttons.
- Datum:** A dropdown menu showing 'Datum 1', with '+ New...' and 'Edit...' buttons.
- Datum Description:** A text field containing 'South pipe end'.
- Datum's Positive Direction:** A text field containing 'Site North'.
- Capture Range:** A text field containing '12 m'.
- Test Name:** A text field containing 'Test 29'.
- Operator:** A text field containing 'PJ'.

A modal dialog box titled 'Pipeline' is open, allowing the user to enter a new pipeline name. The 'Name' field contains 'Pipe 1', and there are 'OK' and 'Cancel' buttons at the bottom of the dialog.

For existing projects, a new pipeline can be entered as above, or an existing pipeline can be selected from the dropdown list.

Pipeline identifications can also be edited, any edits to the pipeline identification will be reflected in all tests performed on that pipeline.

### 3.5.6 Datum

For new projects, a datum can be added by clicking the **New** button and entering the datum name and a description of that datum. This datum will be remembered for subsequent tests.

For existing projects, a new datum can be entered as above, or an existing datum can be selected from the dropdown list.

Datums can also be edited, any edits to the datum will be reflected in all tests performed using that datum.

It is necessary to define the forwards direction relative to the datum position, i.e., in which direction will positive distances be recorded, and which will have negative distances recorded. This can be defined from the selections in the Forwards dropdown box.

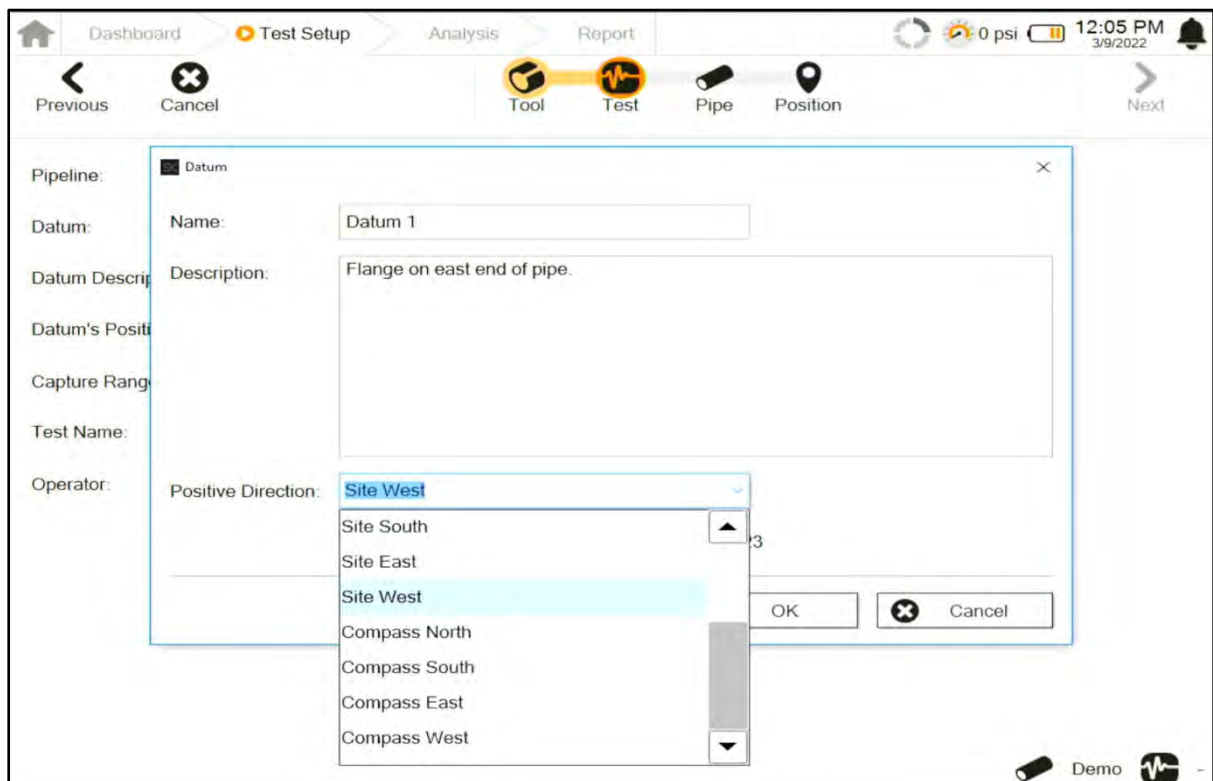

### 3.5.7 Range

Sets the data collection range in both directions. The range cannot be set independently in the forwards and backwards direction, it will be the same for both directions.

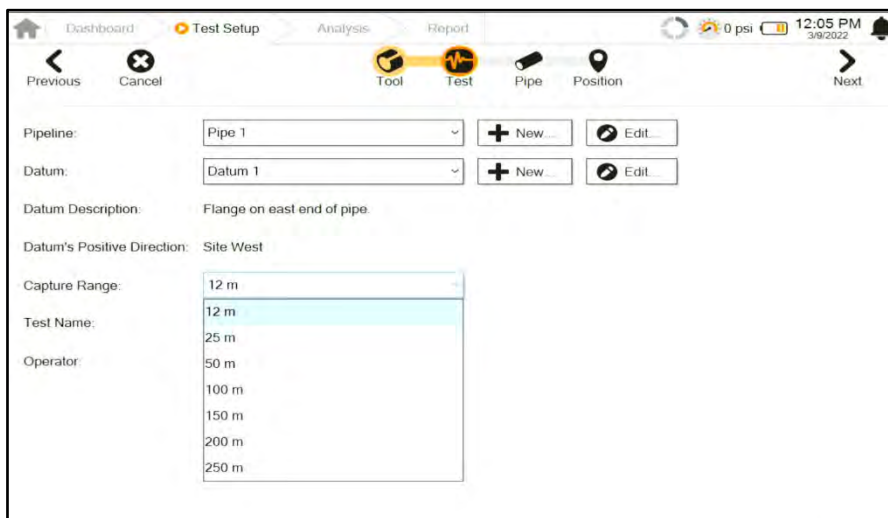

Once the range is defined, the test can be assigned a name. Test names will be assigned automatically by the software in the format of Test 1, 2, 3, etc. but they may be edited manually if required.

The operators name MUST be recorded in the Operator field. This is the name of the technician who conducted the test and does not necessarily need to be the same as the Lead Operator. The operators name will be remembered for subsequent tests.

### 3.5.8 Pulse Length

The pulse length is expressed in number of cycles. If the number of cycles is reduced then axial resolution is increased i.e., features close to each other can be resolved in distance more readily. However, reducing the pulse length increases the frequency bandwidth so should only be considered in situations where the test conditions allow e.g., shorter ranges and at test frequencies where dispersion is unlikely to cause an issue.

**NOTE:** Pulse length cannot be adjusted on the analysis screen, a subsequent acquisition is required.

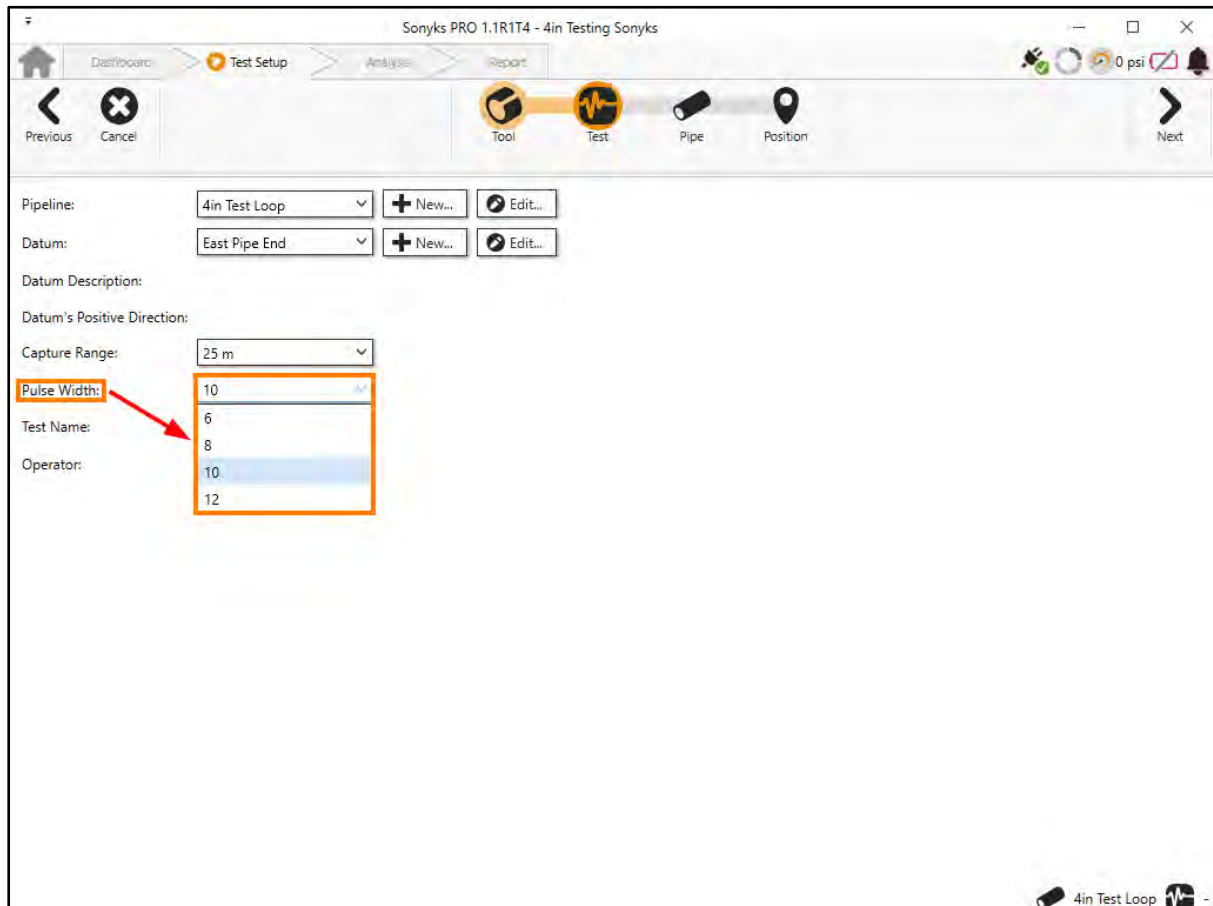

### 3.5.9 Pipe

This is where the pipe details can be entered.

Pipe Details

Material: Carbon Steel

Standard: Aluminum, Carbon Steel, Stainless Steel

Nominal Diameter:

Nominal Thickness: 8.2 mm ( Schedule 40 )

Pipe Temperature:

By default, the material will be set to Carbon Steel. This can be changed to Stainless Steel or Aluminium if required. The selected material will be remembered for subsequent tests.

The available standards are listed below, defaults highlighted in **BOLD**:

Selected Material	Standards Options		
Carbon Steel	ANSI/ASME B36.10M	EN 10220:2002 series 1	None
Stainless Steel	ANSI/ASME B36.19M	JIS G3459	None
Aluminium	None		

The selected Standard will be remembered for subsequent tests.

Pipe Details

Material: Carbon Steel

Standard: ANSI/ASME B36.10M

Nominal Diameter:

Nominal Thickness: None

Pipe Temperature:

The screenshot displays the 'Test Setup' screen in the Sonyks software. The interface is organized into several sections:

- Navigation:** At the top, there are tabs for 'Dashboard', 'Test Setup' (active), 'Analysis', and 'Report'. Below these are navigation buttons: 'Previous', 'Cancel', 'Tool', 'Test', 'Pipe', 'Position', and 'Next'.
- Pipe Details:**
  - Material:** Carbon Steel
  - Standard:** ANSI/ASME B36 10M
  - Nominal Diameter:** 8 in
  - Nominal Thickness:** 8.2 mm (Schedule 40)
  - Pipe Temperature:** A checkbox is present, but no value is entered.
  - Location Notes:** A text area for recording additional information.
- Ultrasonic Thickness Measurements:**
  - Enter Measurements:** A checked checkbox.
  - Measurement Fields:** Four input fields, each showing '0.0 mm', representing measurements at cardinal points.
  - Average Thickness:** 0.0 mm
  - Warning:** A yellow box with a warning icon states 'One or more ultrasonic thickness measurement are not valid.'
- System Status:** The top right corner shows '0 psi' and the time '12:15 PM 3/9/2022'.

The ANSI/ ASME standard will refer to pipe diameters in inches, whereas the EN & JIS standards will refer to pipe diameter in mm. If None is selected for the standard, then the pipe outside diameter will need to be defined manually.

For Carbon and Stainless Steels, the pipes nominal thickness can be selected from the drop-down box. There are also fields for entering the recorded values from manual UT thickness checks at the cardinal points (0°, 90°, 180°, 270°). These fields can be disabled by unchecking the **Enter Measurements** checkbox if required.

For Aluminium, the pipes measured thickness must be entered in the fields for manual UT thickness checks at the cardinal points (0°, 90°, 180°, 270°).

There is also a Location Notes text box for recording any other relevant information pertaining to this test location, i.e., a description of damage visually noted on the weather jacket of an insulated line.

**NOTE:** data acquisition will begin when the **Next** button is pressed from this screen.



### 3.5.10 Pipe Coating

On the Pipe screen there is an option to choose the type of coating used for the pipe being tested. This information is important for the inspection report and can be used to understand attenuation rates experienced during a given test.

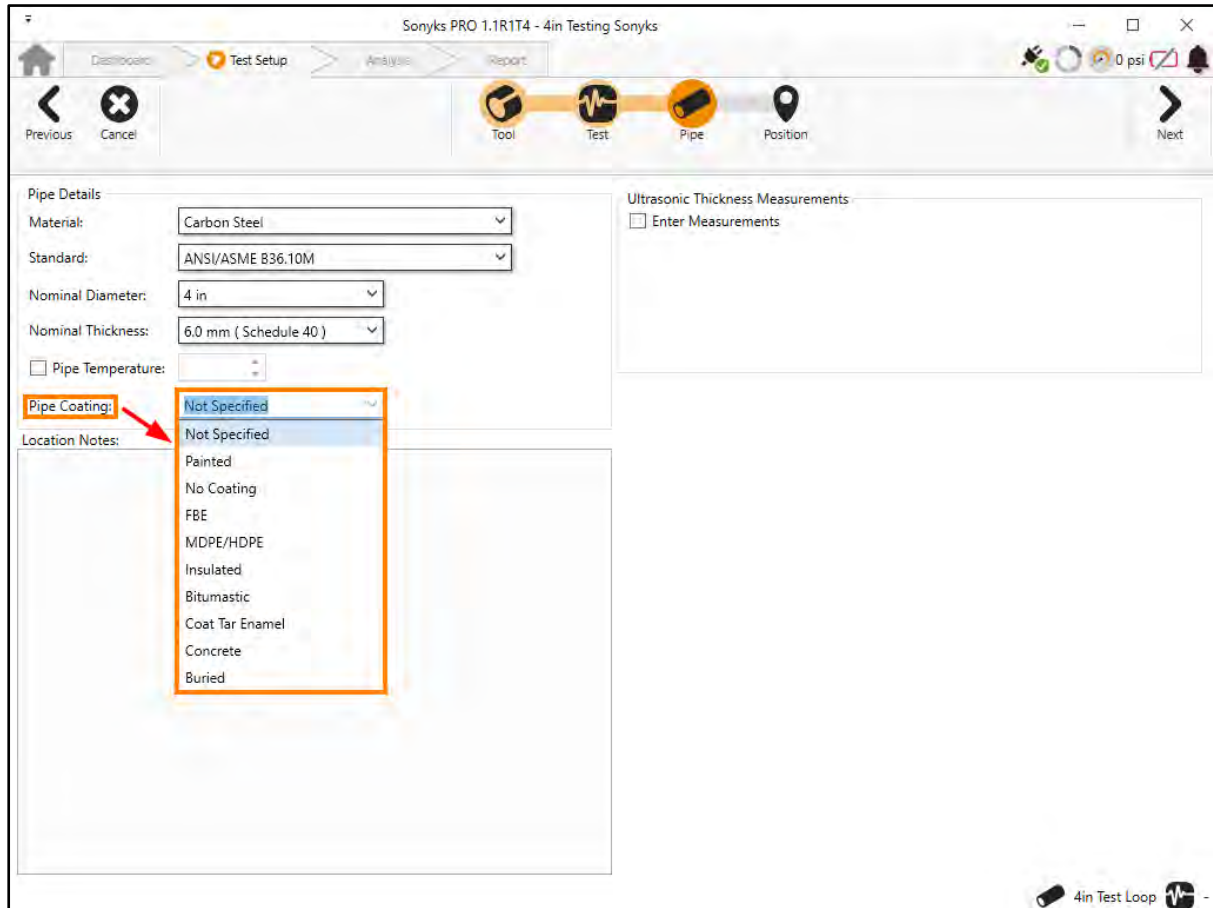

### 3.5.11 Progress Wheel



- 0 segments: Not ready to acquire (user is in dashboard).
- 1 segment: Ready to acquire (tool is configured and wizard is started).
- 2 segments: Acquiring data (along with some processing in parallel).
- 3 segments: Processing (instrument is done with acquisition).
- 4 segments: Processing is done, and user can go to analysis.

### 3.5.12 Position

This is where the datum distance information can be entered.

 A screenshot of the 'Position' configuration screen. The top navigation bar shows 'Dashboard', 'Test Setup', 'Analysis', and 'Report'. Below the navigation bar are icons for 'Previous', 'Cancel', 'Tool', 'Test', 'Pipe', 'Position', and 'Finish'. The main content area is titled 'Pipe 1, Datum 1' and contains the following fields:
 

- Datum Description: Flange on east end of pipe.
- Datum's Positive Direction: Site West
- Pipe Orientation: Horizontal (dropdown menu)
- Tool Position:  In Front Of Datum,  Behind Datum
- Tool Direction:  As Datum (Recommended),  Opposite to Datum
- Tool Distance From Datum: 6.83 m (input field)
- Circumferential Origin Label: Top
- Tool Rotation: 71° (input field)
- GPS: 52.096075°, 0.270318° (with a 'Retry' button)

 To the right of the form are two diagrams: a side view of a pipe with a datum point 'Datum 1 (Site West)' and a tool positioned 6.83 m away, and a top-down view of the tool showing a rotation of 71°.

The tool position relative to the datum should be defined here. The tool direction is also defined here (tool forwards same as datum forwards or opposite to it).

The distance from the tool centre to the datum position should be recorded in the relevant field.

The pipe orientation can be either horizontal or vertical. Vertical configurations will need the **Circumferential Origin** (Top Dead Centre or 0°) Label defining.

The **Tool Rotation** field can be used to apply a rotational offset to the data if it has not been possible to position the tool with the tool TDC aligned to the pipe TDC. This will be assigned automatically for Piezo-Tools (as shown).

## 3.6 Analysis Screen

### 3.6.1 A-scan Display



The A-scan display can be switched on and off by clicking on the A-scan tab on the right.

#### 3.6.1.1 Data Views



The three buttons above change the A-scan presentation view.



**Linear:** This is the traditional view for A-scans. The y-scale is divided into equal units for equal values.



**Log:** This is a logarithmic view. The y-scale uses a power of 10 scale, meaning that each division is an order of magnitude larger than the previous one. It can be useful for observing signals over a long distance where there is a high dynamic range, i.e. vary large and very small amplitude signals.



**TCG:** This is a Time Corrected Gain view. It can only be used when the DAC Curves have been set. It normalises the signals relative to the DAC Curves. In this view, the DAC Curves will be flat horizontal lines. This view can be used to filter relevant from non-relevant signals.

**NOTE:** Due to the fact that the amplitude of girth welds on the A-scan are used to calculate DAC Curves, they are not editable in TCG mode. Features not used to calculate DACs will be editable in this mode.

### 3.6.1.2 Vector Display



The vector display can be selected by clicking the  button shown above. The vector display shows both the horizontally and vertically polarised flexural modes.

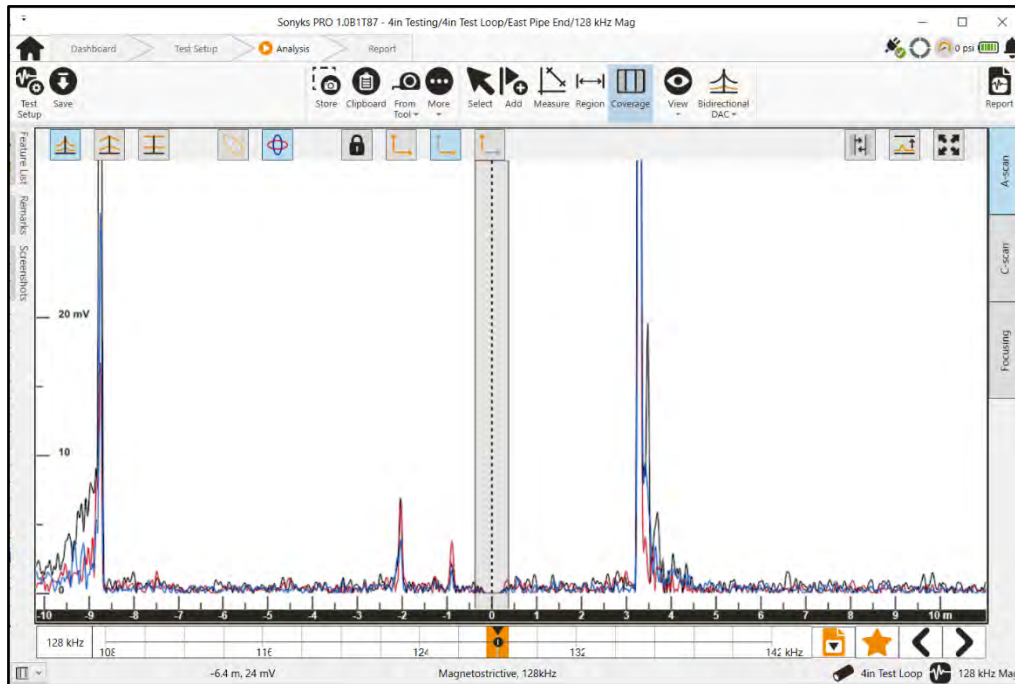

### 3.6.1.3 Magnitude Display



The magnitude display can be selected by clicking the  button shown above. The magnitude display shows maximum amplitude of the un-polarised flexural mode.

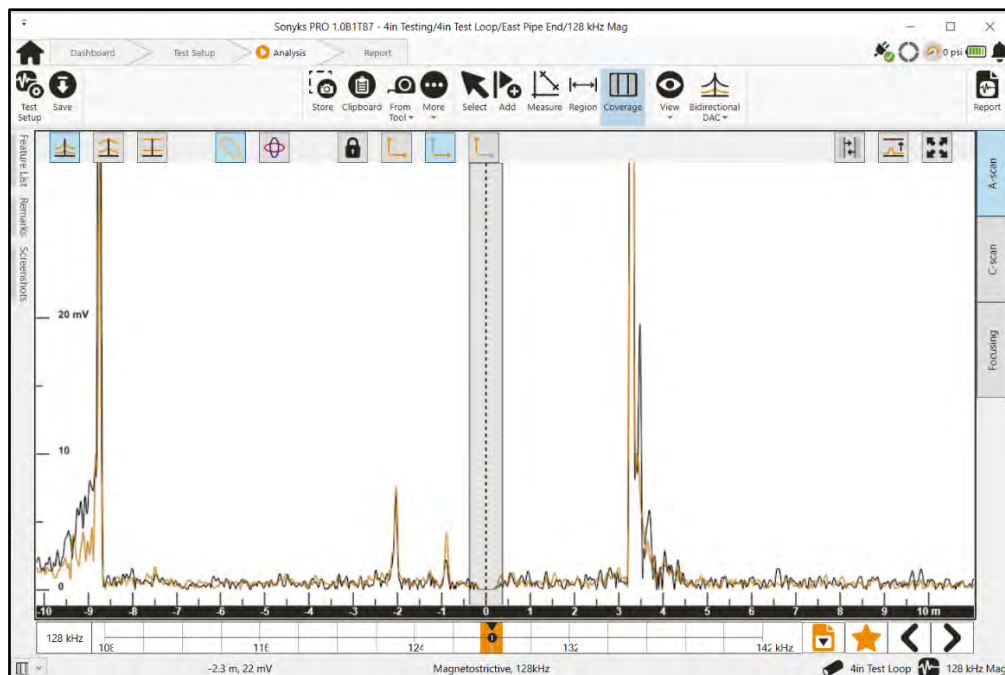

### 3.6.1.4 Panning and Zooming

In Sonyks PRO (PC) Panning can be performed by holding down the right mouse key and dragging the data to the left, right, up, or down.

Zooming can be performed by using the mouse wheel. The zoom will be centred around the mouse pointer.

In Sonyks GO (Embedded) panning is performed by dragging the screen in the desired direction with a finger, or by using the Arrow keys (in panning mode). Zooming is performed by pinching to zoom, or by using the Arrow keys (in zoom mode).



The four buttons above control the zooming behaviour.



This locks the screen and prevents zooming.



Rolling the mouse wheel will zoom in and out on both axes simultaneously.



Rolling the mouse wheel will zoom in and out on the x-axis (distance) only. This is the default selection



Rolling the mouse wheel will zoom in and out on the y-axis (amplitude) only.



The two buttons above can be used to show the diagnostic length cursors, auto-set & reset the zooming and panning of the a-scan.



Auto fit: This will scale the y-axis to fit the highest amplitude signal in the section of data currently presented.



Reset: This will rescale the x-axis to the diagnostic length cursors and the y-axis to fit the maximum amplitude signal within that range.

## 3.6.2 A-scan Toolbar

### 3.6.2.1 Adding Features

#### 3.6.2.1.1 Trace Tracking

To assist with annotating signals, the cursor will track along the selected trace in this mode. In Sonyks PRO (PC), the cursor will follow the mouse pointer. In Sonyks GO (Embedded) the cursor can be controlled with the Arrow keys (in Add mode). In this mode the Select key (tick) will add the last used feature type to the peak of the signal.

#### Order 0 – Axisymmetric Trace



The Axisymmetric mode can be selected with the button above. Selecting this button will allow the cursor to track along the black trace.

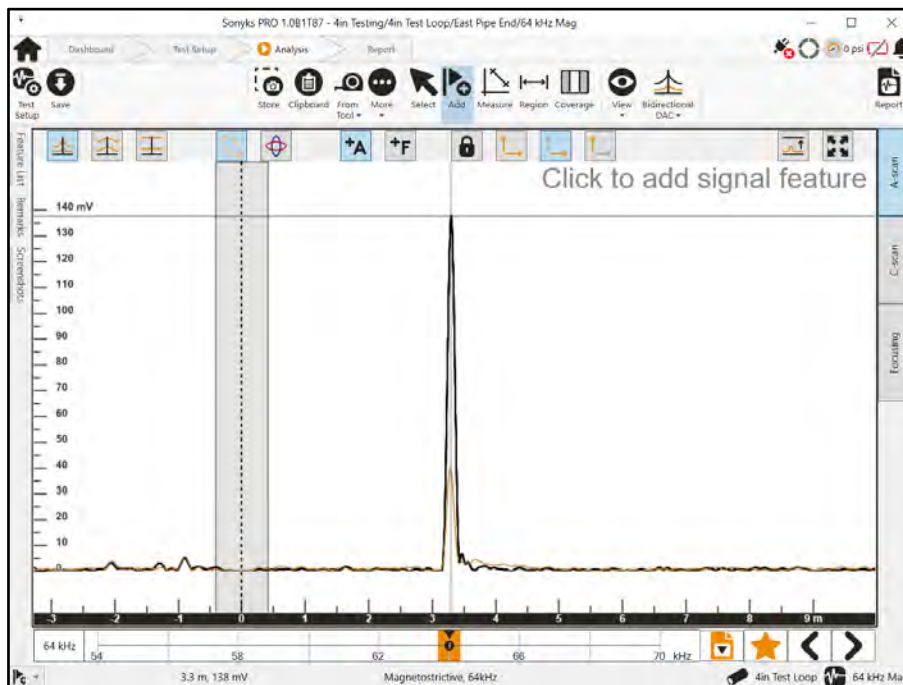

Order 1 – Flexural Trace



The Flexural mode can be selected with the button above. Selecting this button will allow the cursor to track along the brown trace if the Magnitude display is selected or either the red or blue trace (whichever is higher) if the Vector display is selected.

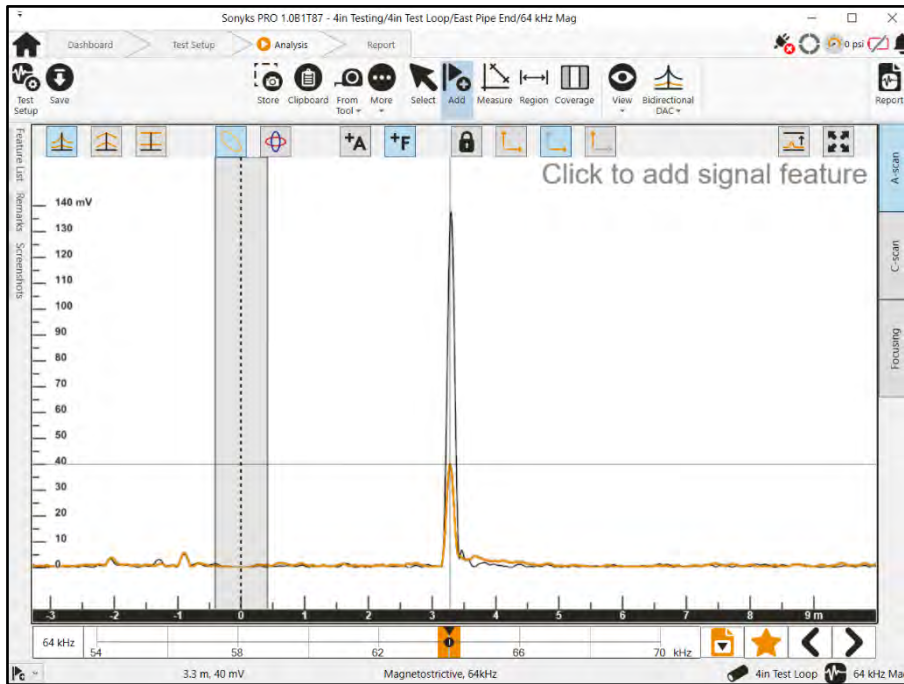



### 3.6.2.2 Normalisation Weld

The normalisation weld is a feature used to balance the output of the transducer segments within the tool. The Sonyks software determines and labels this normalisation weld automatically. The weld is marked with the following symbol:



The Analysis view below shows the normalisation weld as the first weld in the forwards direction.

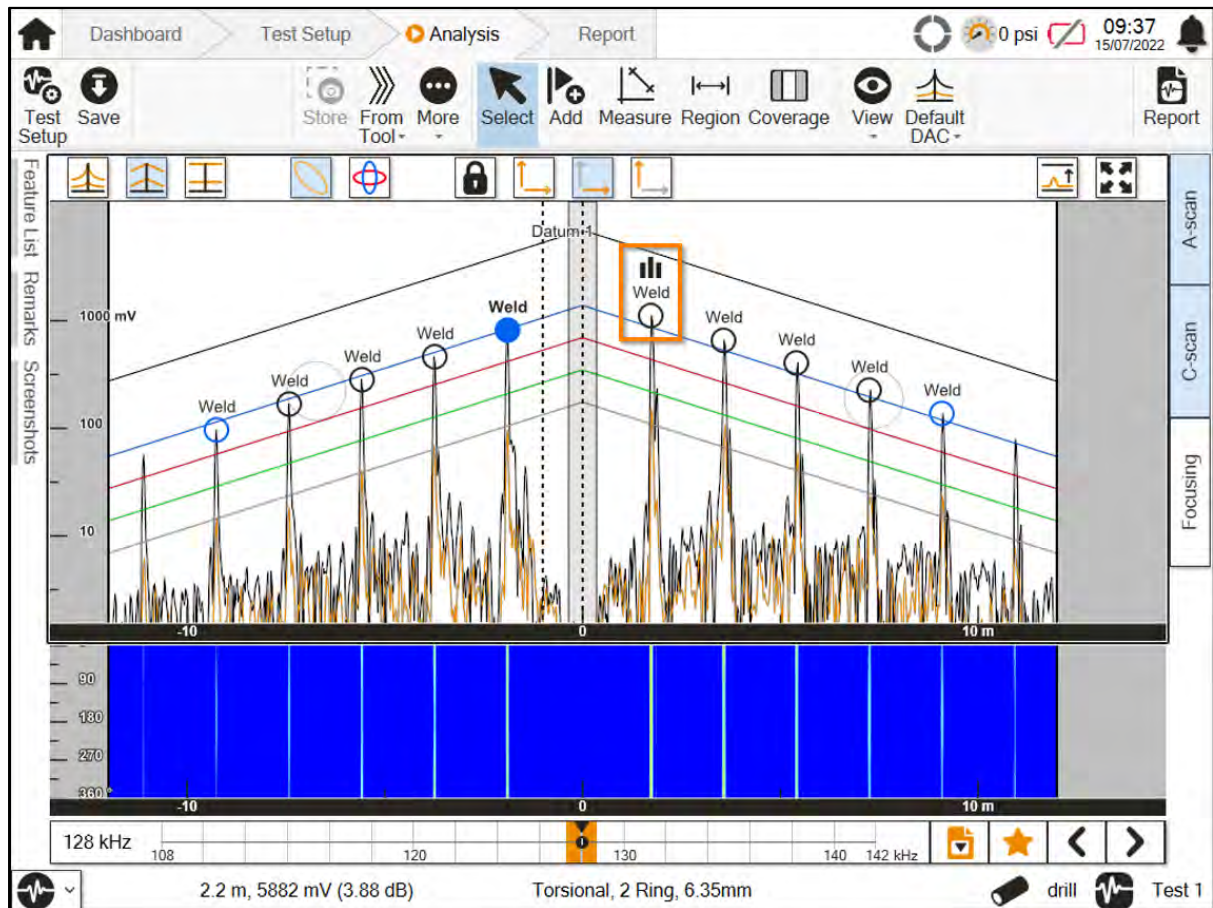



### 3.6.2.3 Radial Menu

Clicking on the peak of a signal will add a feature. The indication will be labelled with the last used feature name. A radial menu will appear around the indication.

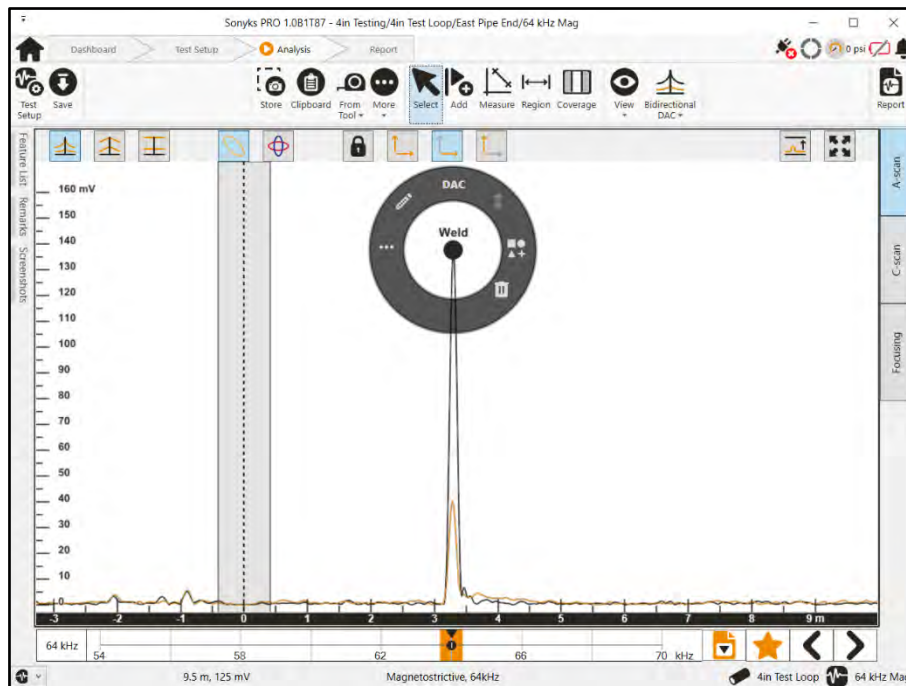

The radial menu displays the following options:

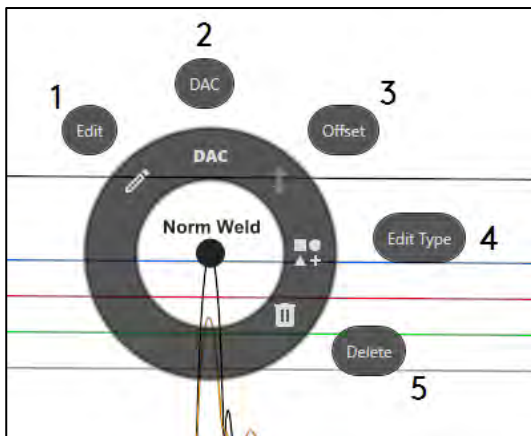

1. Edit feature name
2. Set DAC point
3. Adjust DAC point
4. Change feature type
5. Deletes feature

### 3.6.2.3.1 Change Feature Type

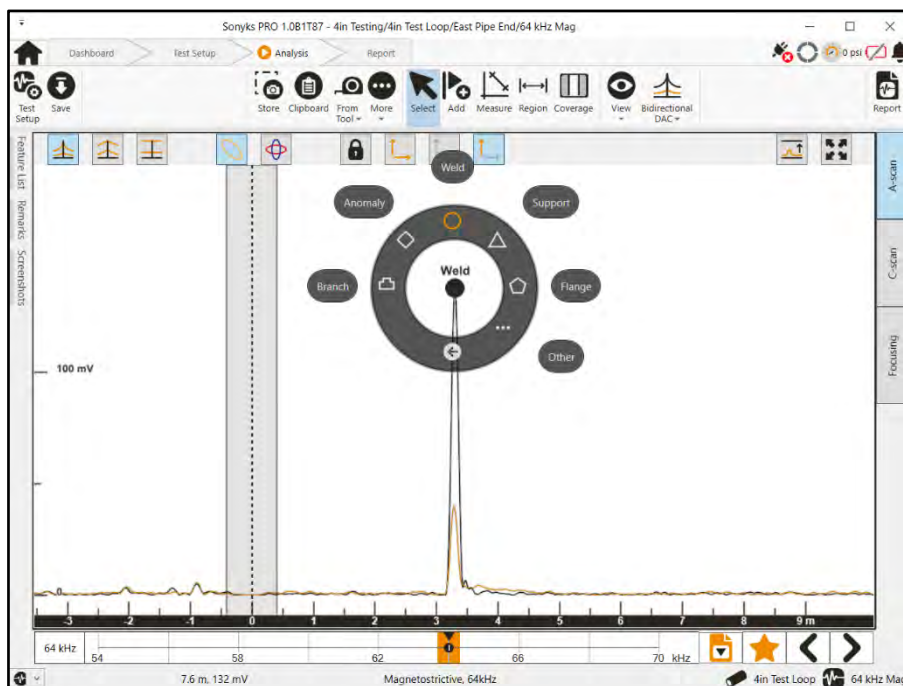

Some of the items on the feature type menu offer sub-menus.

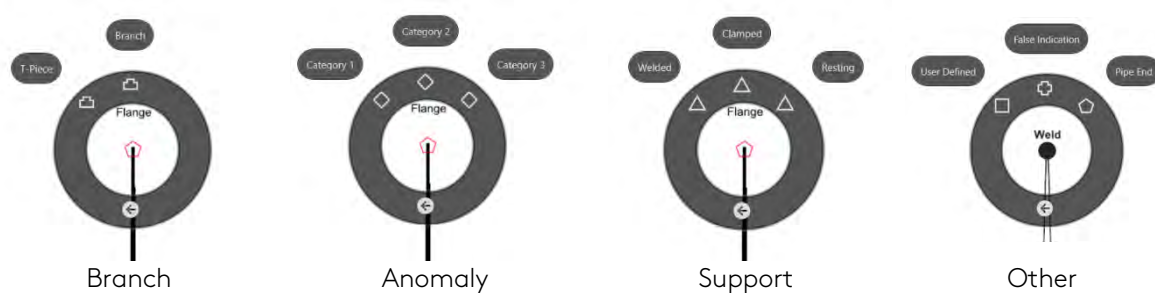

← In any sub-menu you can use the back button to return to the previous menu option.

### 3.6.2.4 Edit Feature Name

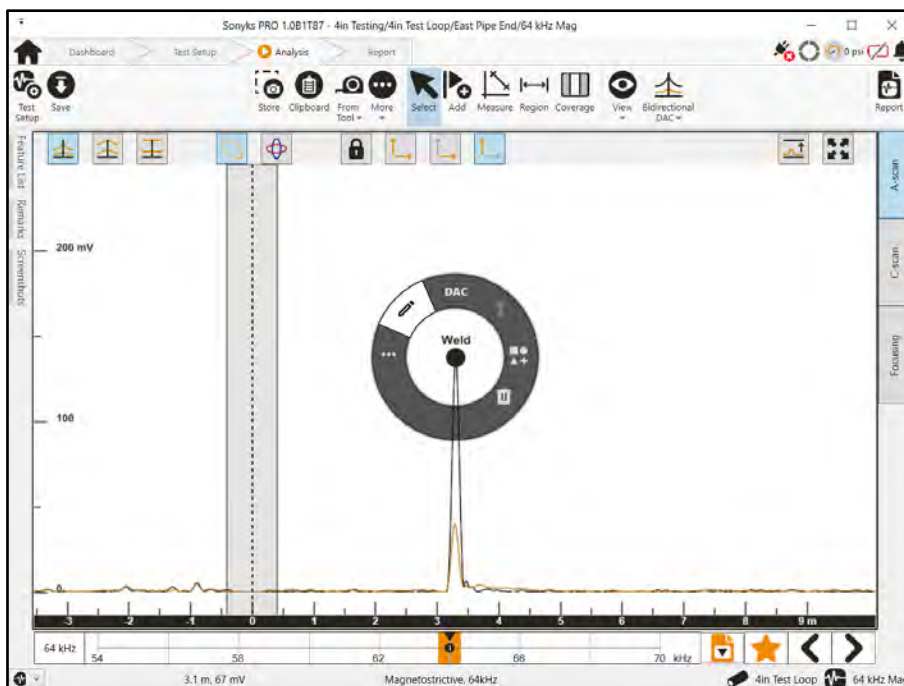

The Edit Feature Name function allows the user to overwrite the standard feature Name. It also provides a text box for adding additional information to a features description.

The screenshot shows the 'Edit Feature' dialog box. The dialog has a title bar with the Sonyks logo and the text 'Edit Feature'. Inside the dialog, there is a 'Name:' label followed by a text input field containing the text 'Weld'. Below this is a 'Comment:' label followed by a large text area. At the bottom of the dialog, there is a checkbox labeled 'DAC' which is currently unchecked. At the very bottom of the dialog, there are three buttons: 'Delete' (with a trash icon), 'OK' (with a checkmark icon), and 'Cancel' (with a close icon).

### 3.6.2.5 DAC Curve Setting

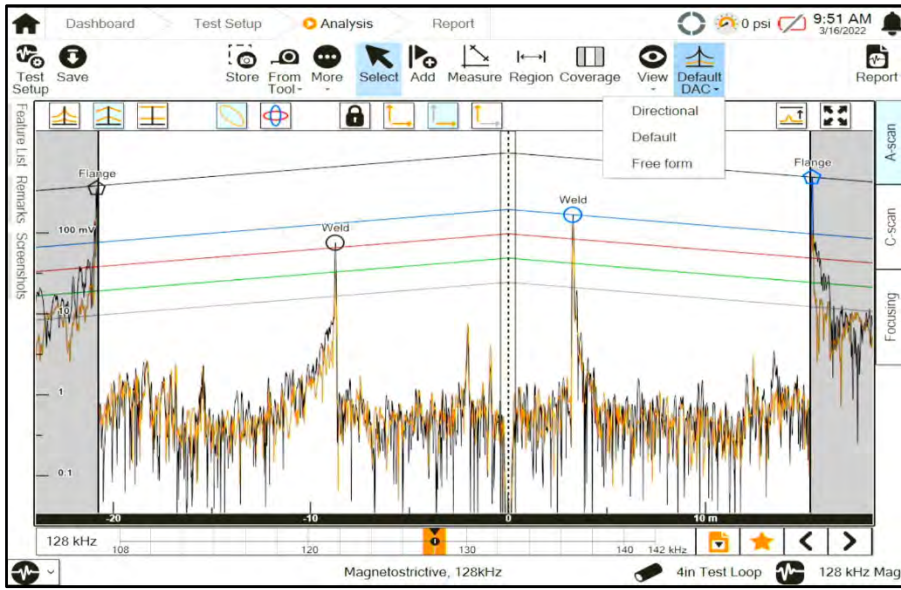

There are three DAC modes available: Default, Directional, and Free form.

#### 3.6.2.5.1 Default DAC

The Default DAC is constructed by referencing any two points (Welds, Flanges or Pipe Ends) to construct the DAC curves. The two points used can be in either direction, i.e., one weld in each direction or both welds in one direction. The two points should not be at the same or similar distances from the tool, e.g., +6m and -6m. It assumes that the attenuation rate is equal in both directions. Select the first feature and use the **DAC menu** button to assign a DAC setting point to this feature.

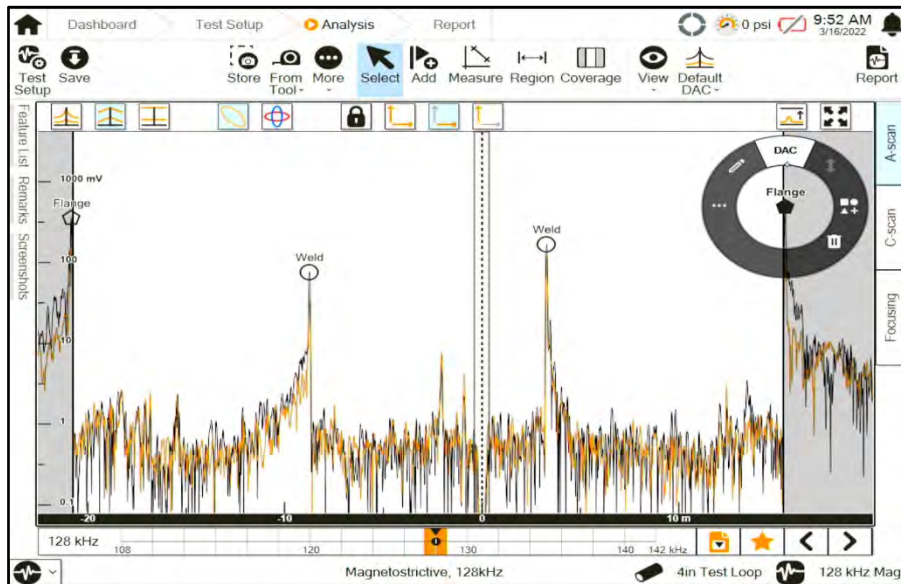



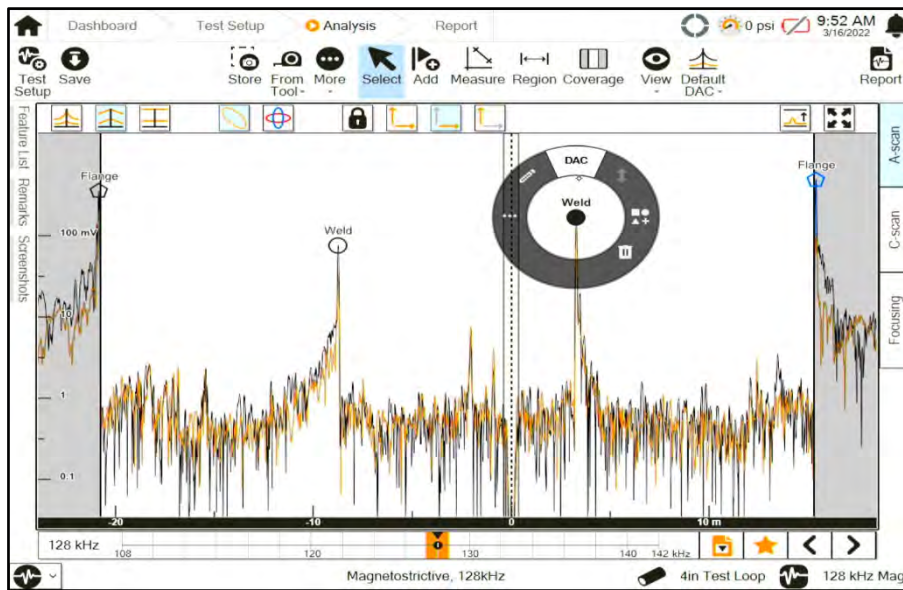

Select the Second feature and use the DAC menu button to assign a DAC setting point to this feature. The software will set the DAC curves in both directions based on these two points (highlighted in blue).

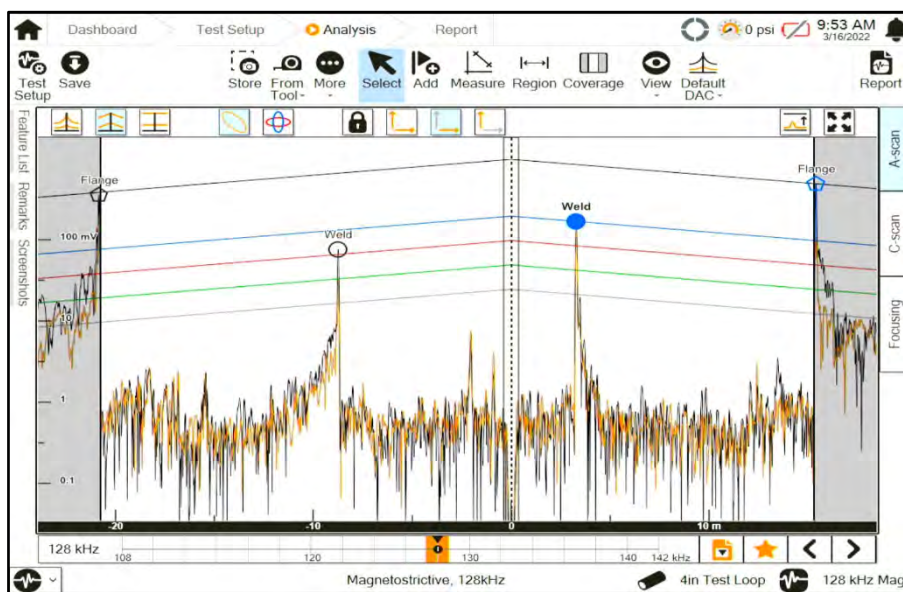

### 3.6.2.5.2 Directional DAC

The Directional DAC is constructed by referencing any two points (Welds, Flanges or Pipe Ends) in each direction, i.e., two in the forwards direction and two in the backwards direction. This makes it useful in situations where the attenuation rate is different in the forwards and backwards directions, e.g., the pipe is above ground in the backwards direction but buried in the forwards direction.

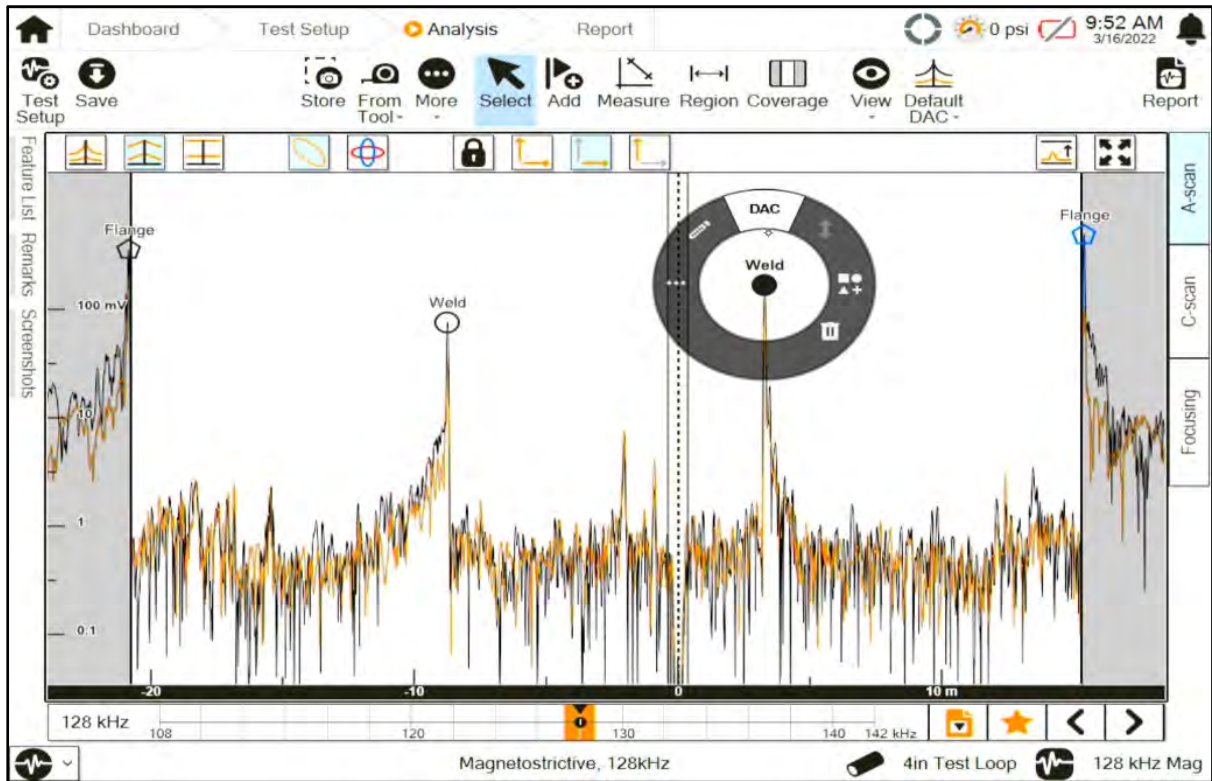

To set the DAC curves set two points in each direction as DAC points using the radial menu. The DAC curves will be constructed across these two points.

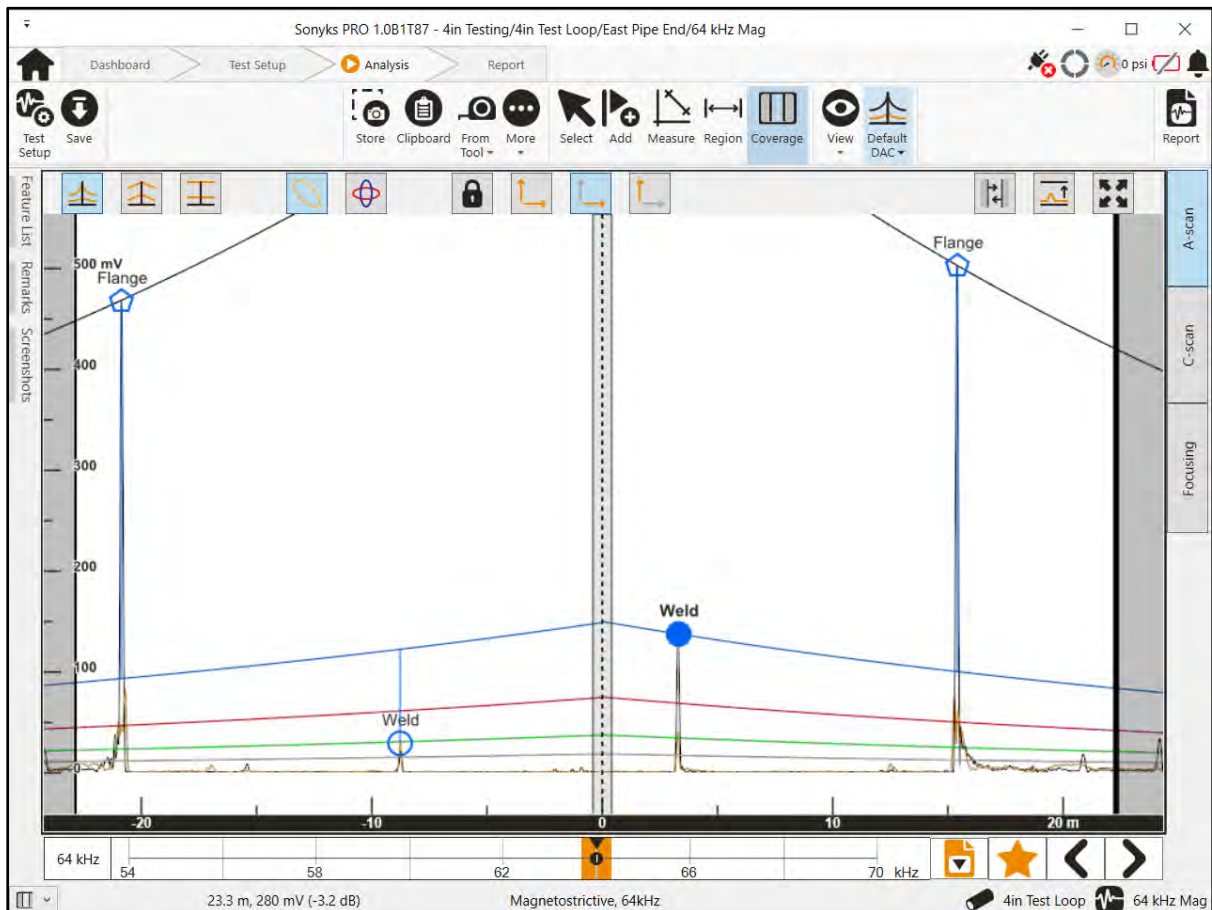



### 3.6.2.5.3 Freeform DAC

The Freeform DAC is constructed by manually manipulating the DAC curves to their desired position. Two circular manipulation points will be displayed on the DAC curves in each direction. Each point can be moved horizontally and vertically to a reference point, e.g., the peaks of two welds. The DAC curve will be drawn between these two points.

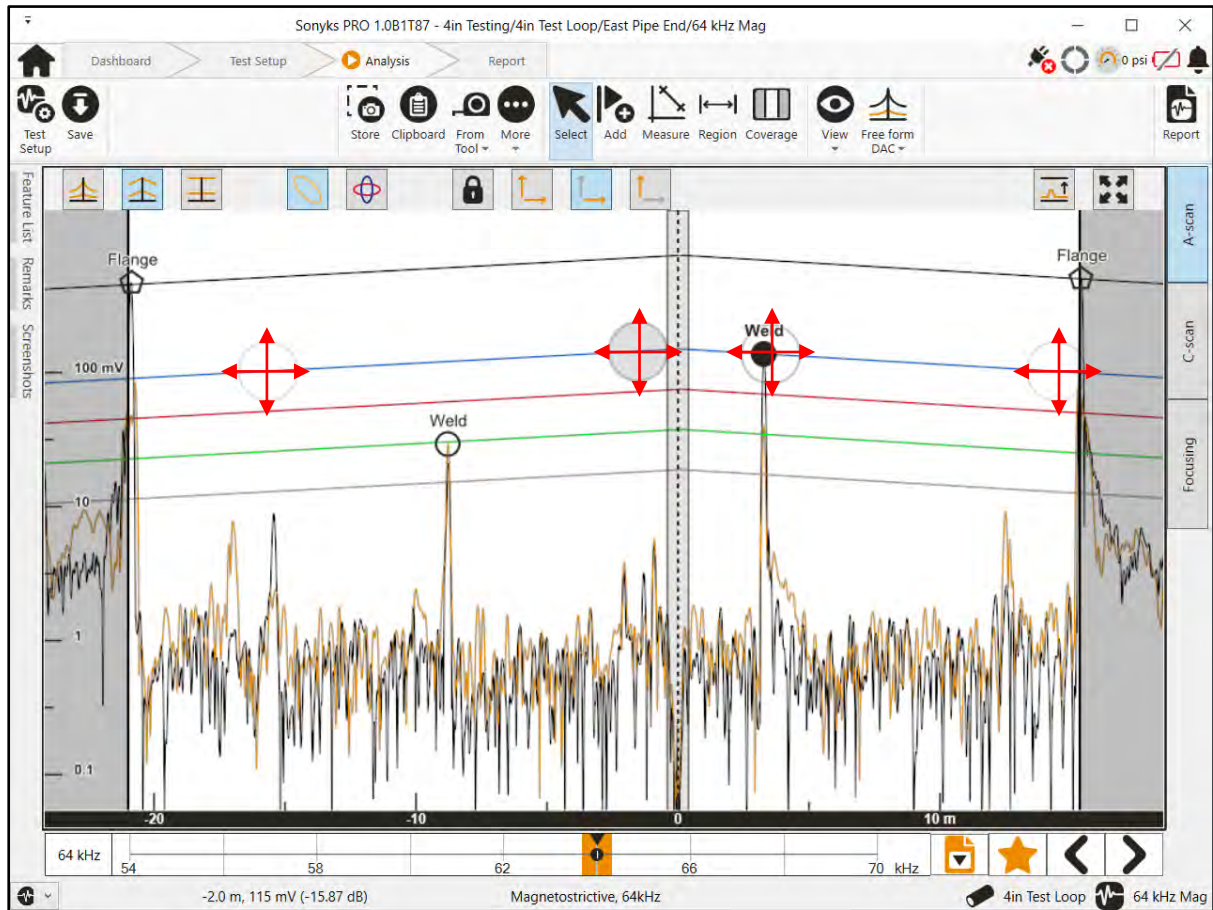

### 3.6.2.5.4 Adjusting DAC Curves

Feature Point Offset

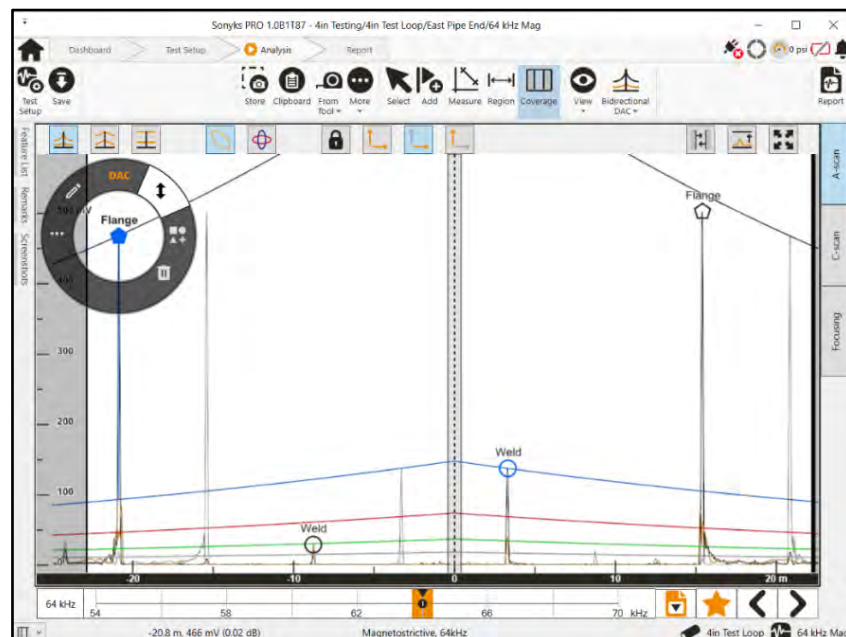

This allows the DAC to be adjusted by entering an offset to a feature in dB.

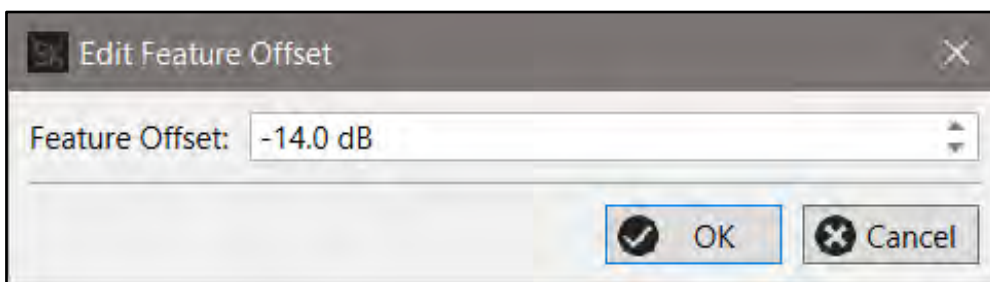

### Global Offset

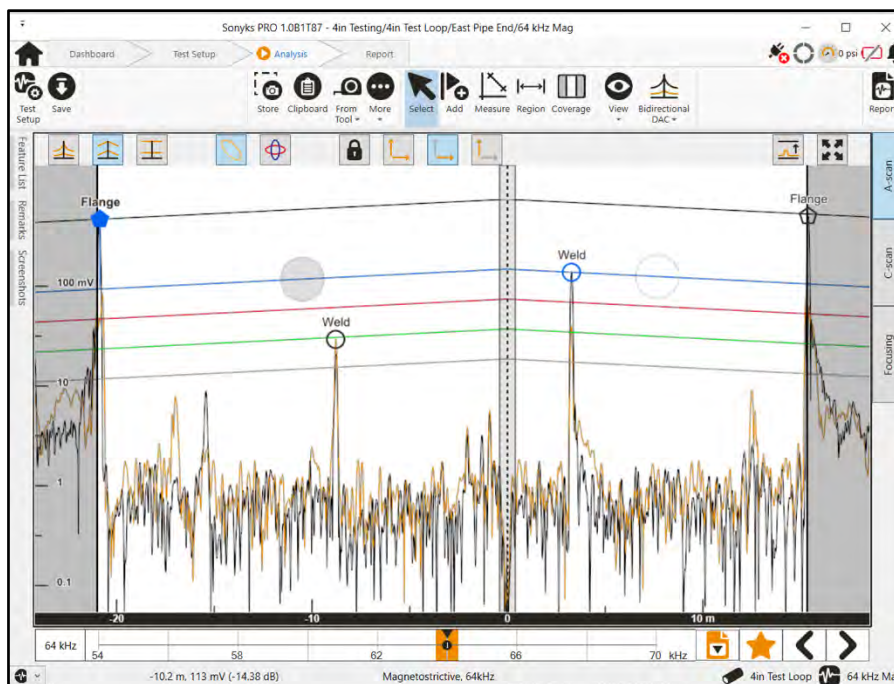

This operation can be performed in either the Default DAC mode or the Directional DAC mode. It allows the DAC level to be adjusted manually by clicking in the grey circle and dragging it up or down. The attenuation rate cannot be adjusted in this way.



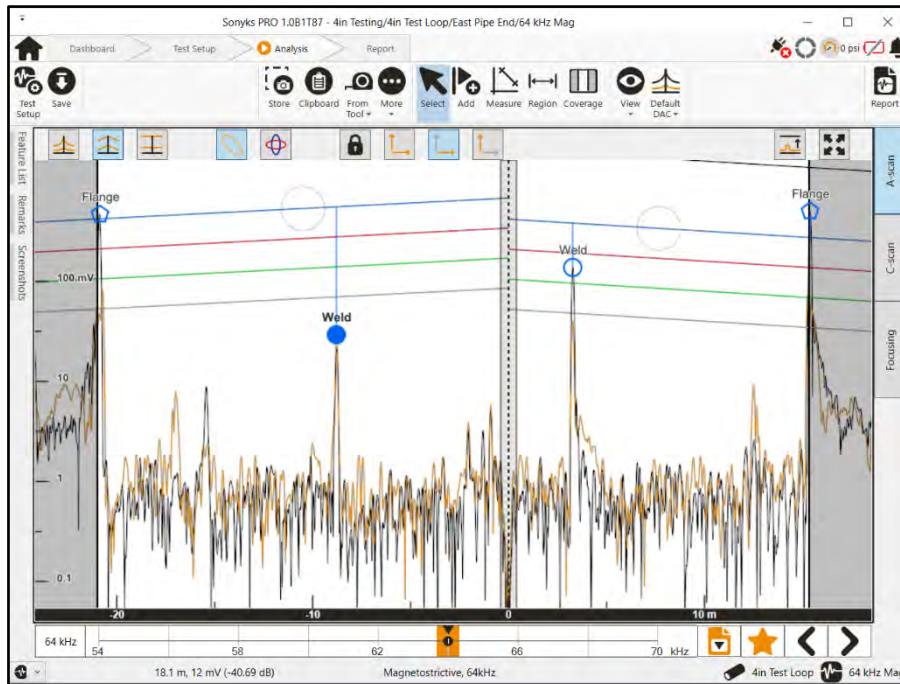

When in the Default DAC mode, the level of the forwards and backwards DAC curves will be adjusted equally. When in the Directional DAC mode, the level of the forwards and backwards DAC curves can be adjusted independently.

### 3.6.2.6 Coverage

This allows the user to adjust the cursors used to mark the diagnostic limits.



When this option is selected an additional button will appear in the top right of the A-scan display.



Display diagnostic length cursors: If the cursors are positioned outside of the zoomed area, clicking this button will cause them to be positioned within in the currently zoomed region.

### 3.6.2.7 Measurement Tool

The measurement tool is activated using the **Measure** tool bar button.

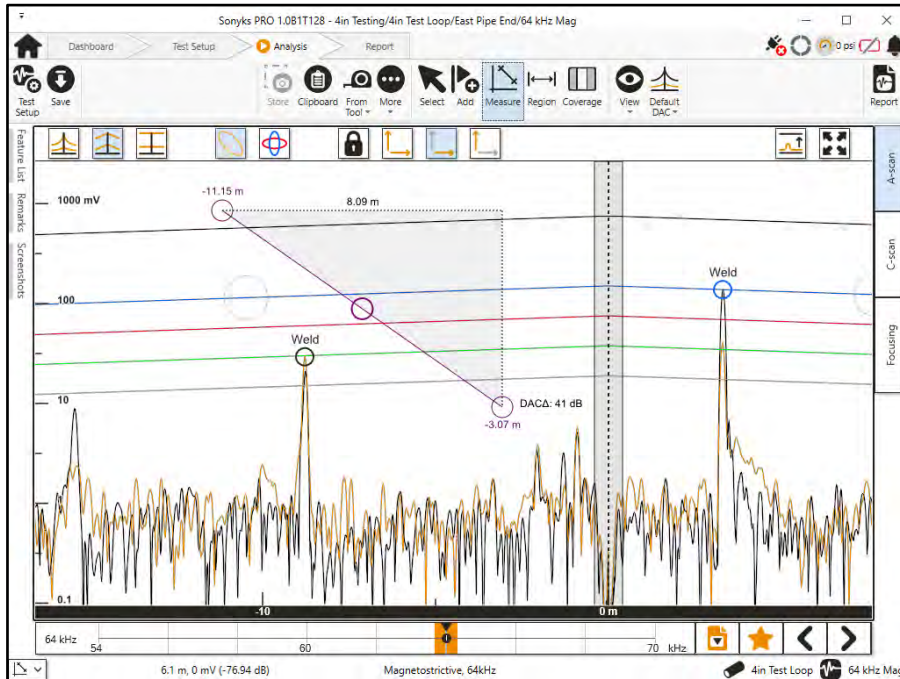

The measurement tool can be positioned by grabbing and dragging the circles at either end of the measurement bar. The whole tool can be moved in position by grabbing the circle in the middle. The measurement tool can be adjusted using the arrow keys on the keyboard (Sonyks PRO) or with the Arrow buttons (Sonyks GO). When using the arrow button (Sonyks GO) the Select key (tick) can be used to cycle through the circles. The highlighted circle (either end or the middle) will move. Movement of the measuring tool is independent of screen scrolling so the measurement tool will always appear at the same position on the screen, although the values will update as the screen is panned and zoomed. The values shown at either end of the measurement bar (in purple) are distance from tool or datum (dependant on x-axis mode).

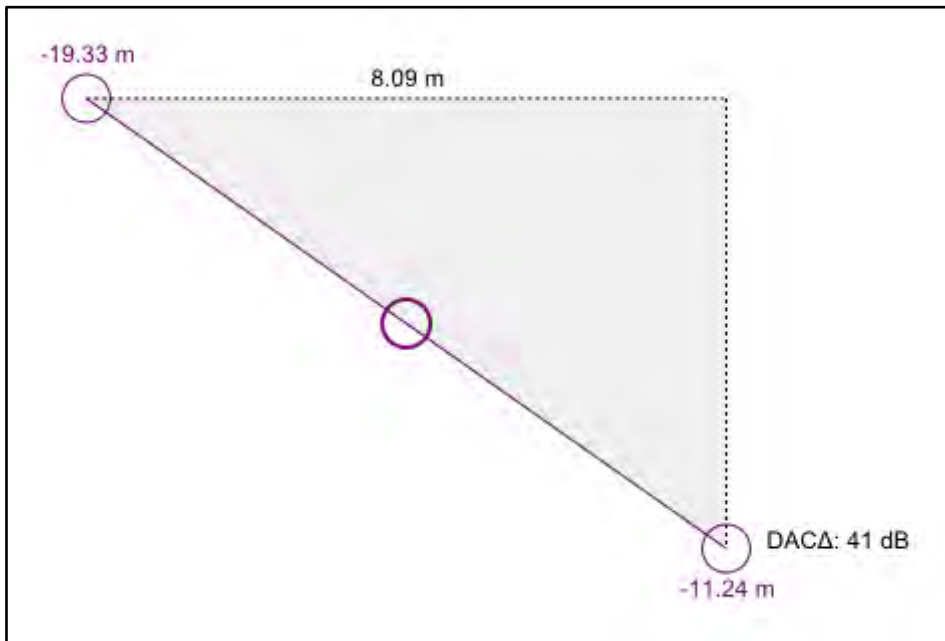

The distance between the two cursors is shown (in black) on the x-axis in (m/ft). The difference in amplitude values is shown (in black) on the y-axis in dB. The DACΔ dB value is gain corrected, not an absolute (based on mV) value.

### 3.6.2.8 Region Tool

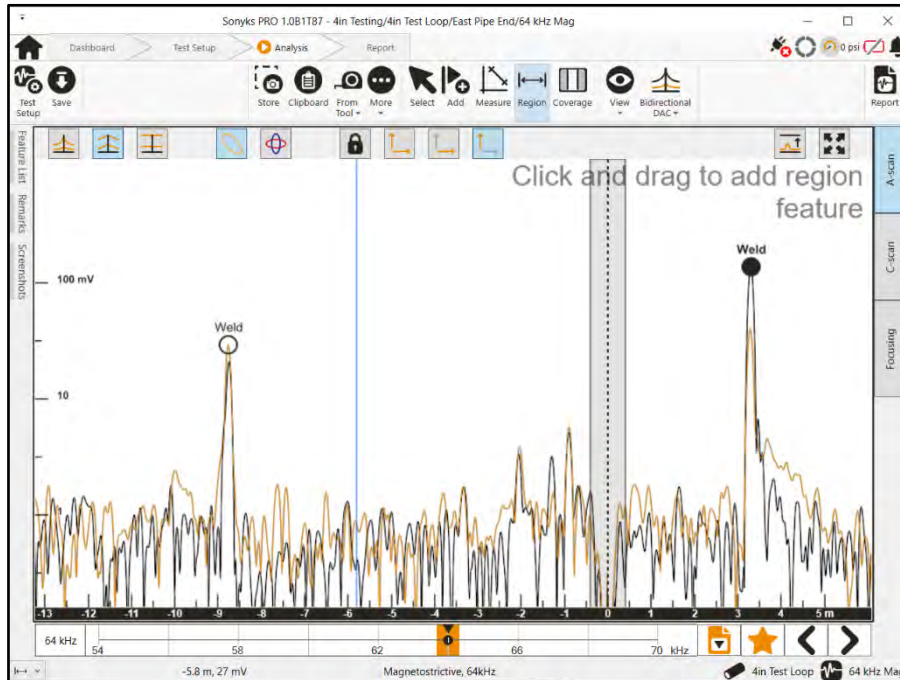

A Region can be added to highlight a whole area by clicking and dragging the tool over the area.

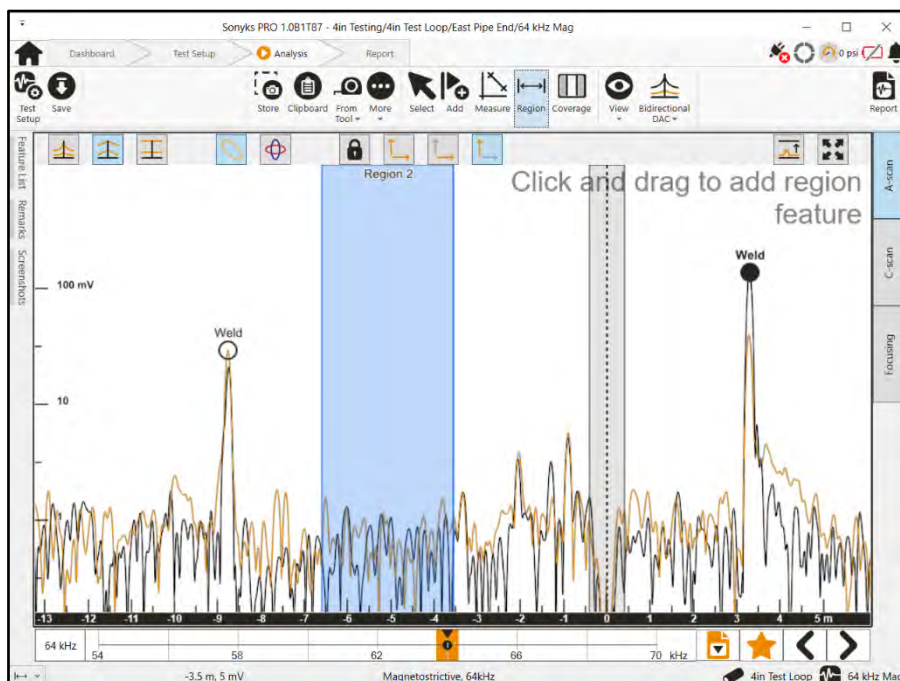

Once placed the Region can be edited by using the Select tool. Clicking on the Region with the select tool will open the Edit Feature menu.

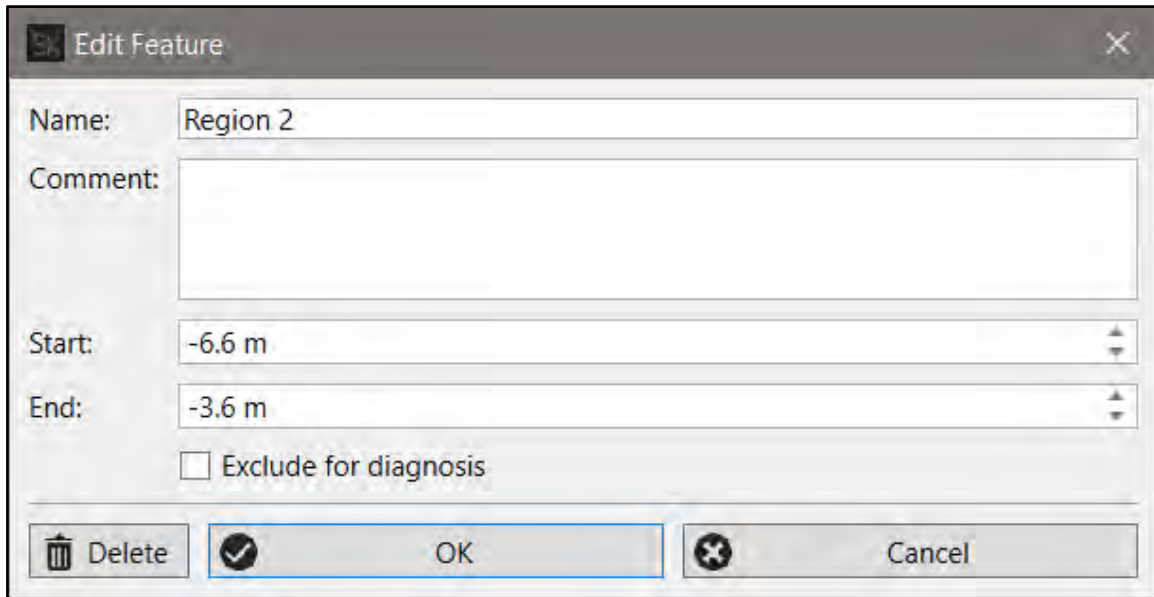

### 3.6.2.9 View Menu

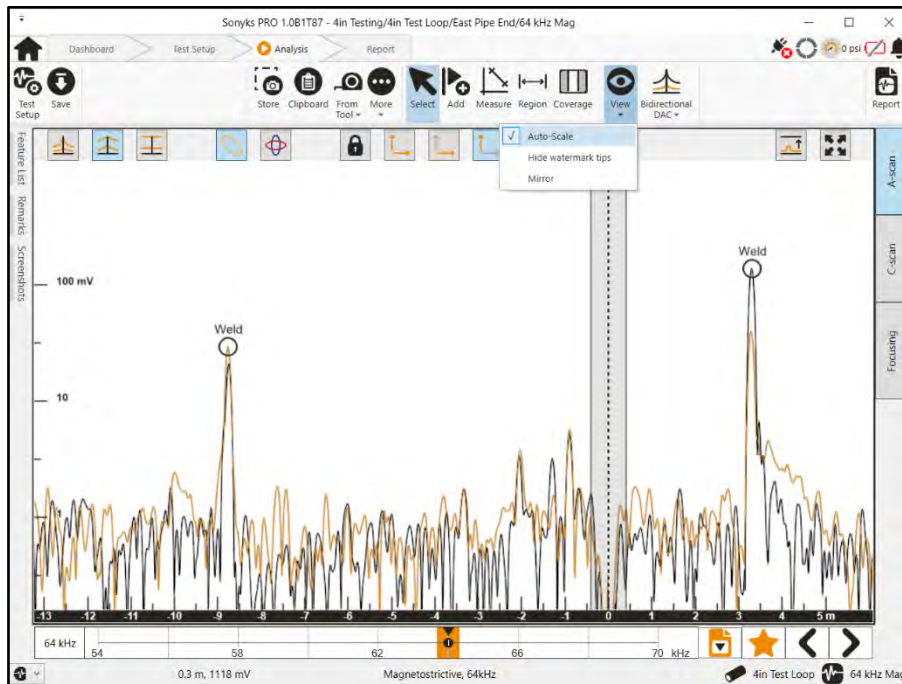

#### 3.6.2.9.1 Auto-scale

This option is switched on by default.

It allows the y-scale of the A-scan to automatically adjust the scale as the frequency is adjusted. This ensures that largest amplitude signal is always maximised on the screen as the frequency is adjusted.

#### 3.6.2.9.2 Hide watermark tips

This will disable the onscreen tips for the Add Features and Region tools



### 3.6.2.9.3 Mirror

This feature shows the predicted position of Mirror signals on the A-scan.

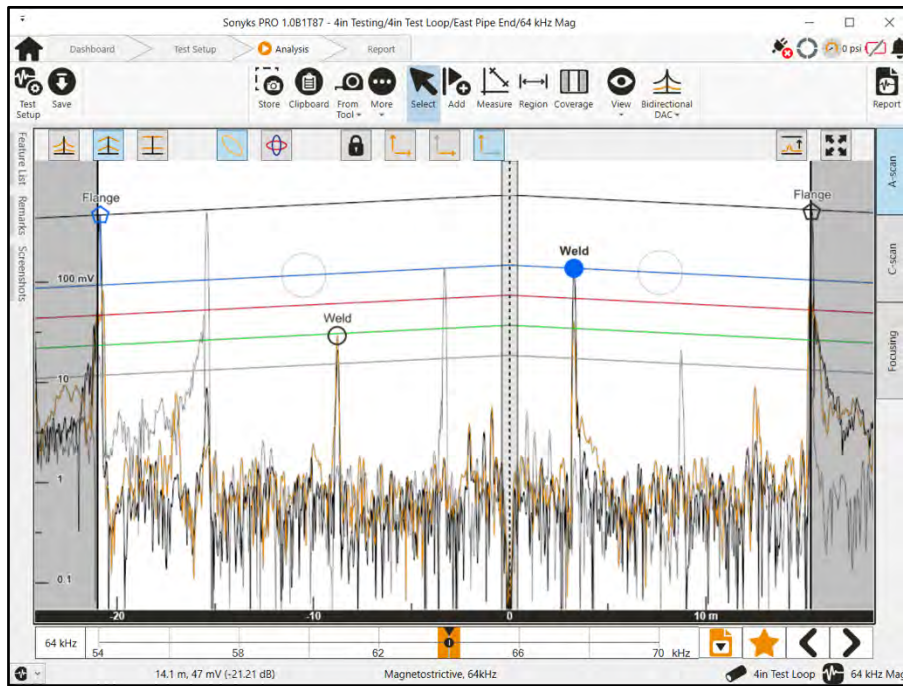

### 3.6.2.10 More Menu

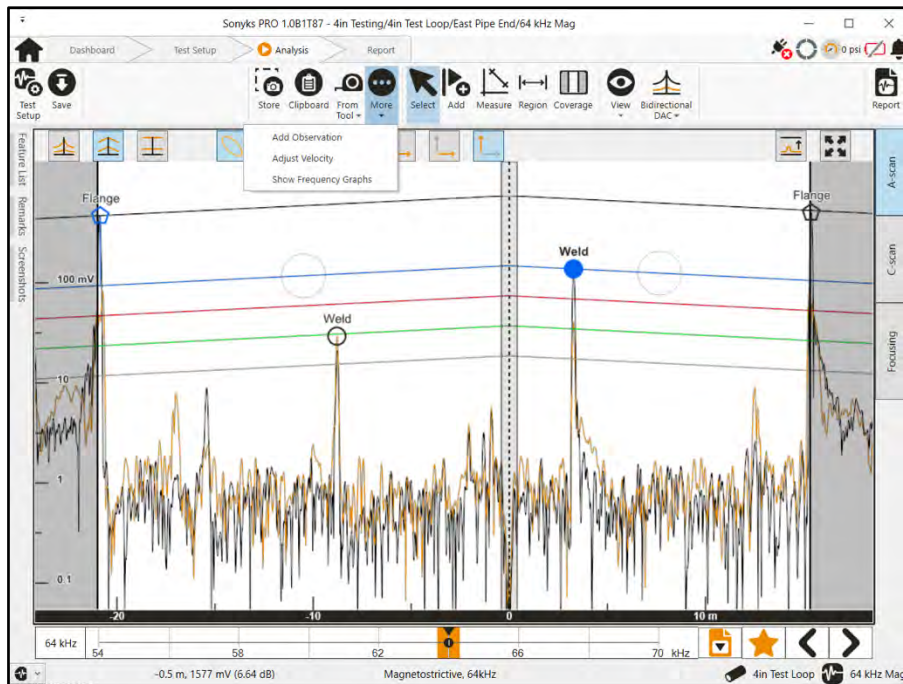

#### 3.6.2.10.1 Add Observation

Add a visually observed feature to the A-scan. Can be used to mark a reference position of something that does not give a guided wave response.

### 3.6.2.10.2 Calibrate Distance

This tool is essentially used to adjust the wave velocity and therefore relative distances on the A-scan. The velocity can be calibrated by using two features at a known distance between them (*Measured Separation*). The difference between the measured wave velocity and the theoretical wave velocity given by the dispersion curves is expressed as a percentage.

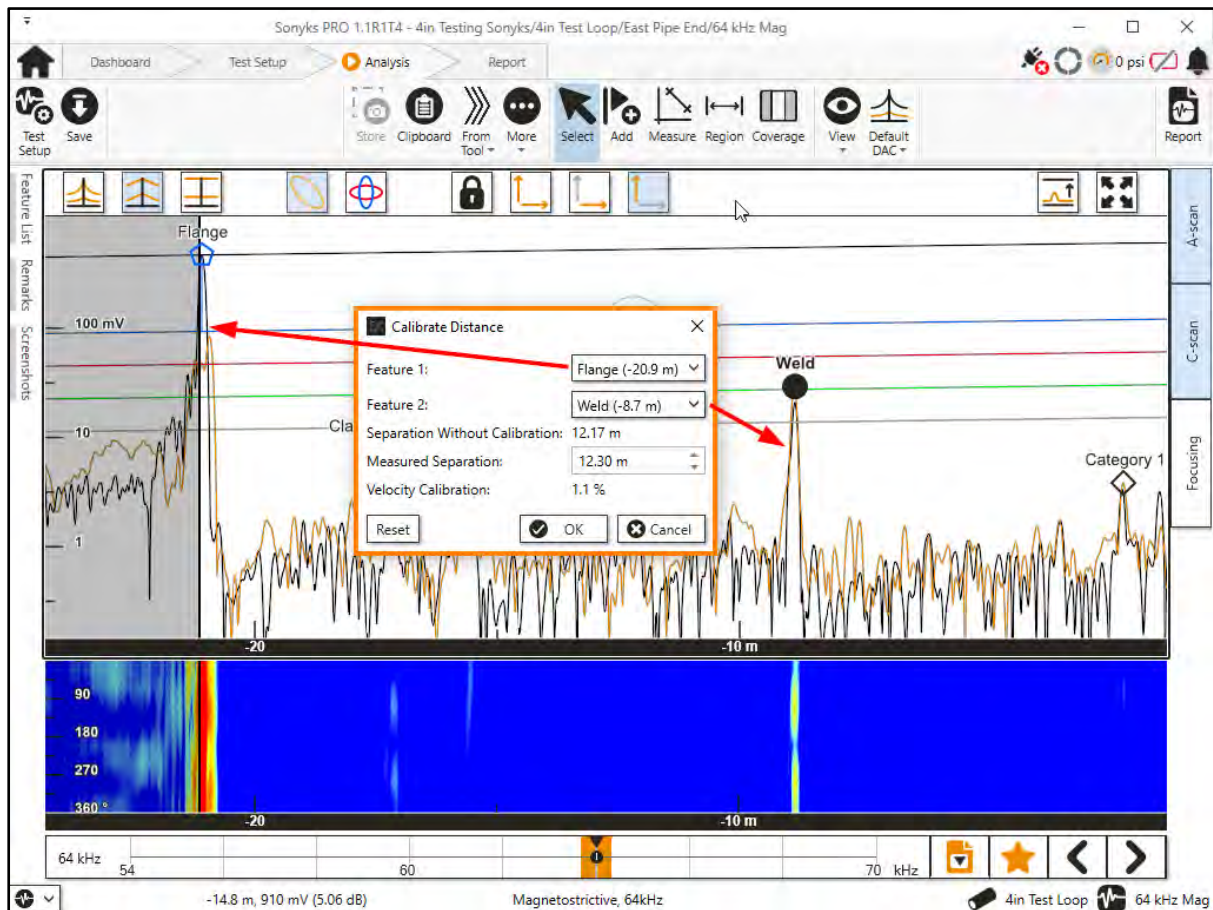

### 3.6.2.10.3 Show Frequency Graphs

Display the dispersion curves and power output curves.

### 3.6.2.11 From Datum/ Tool

By default, the x-axis will show distance with respect to the tool position. This can be changed by selecting the **From Tool/Datum** button.

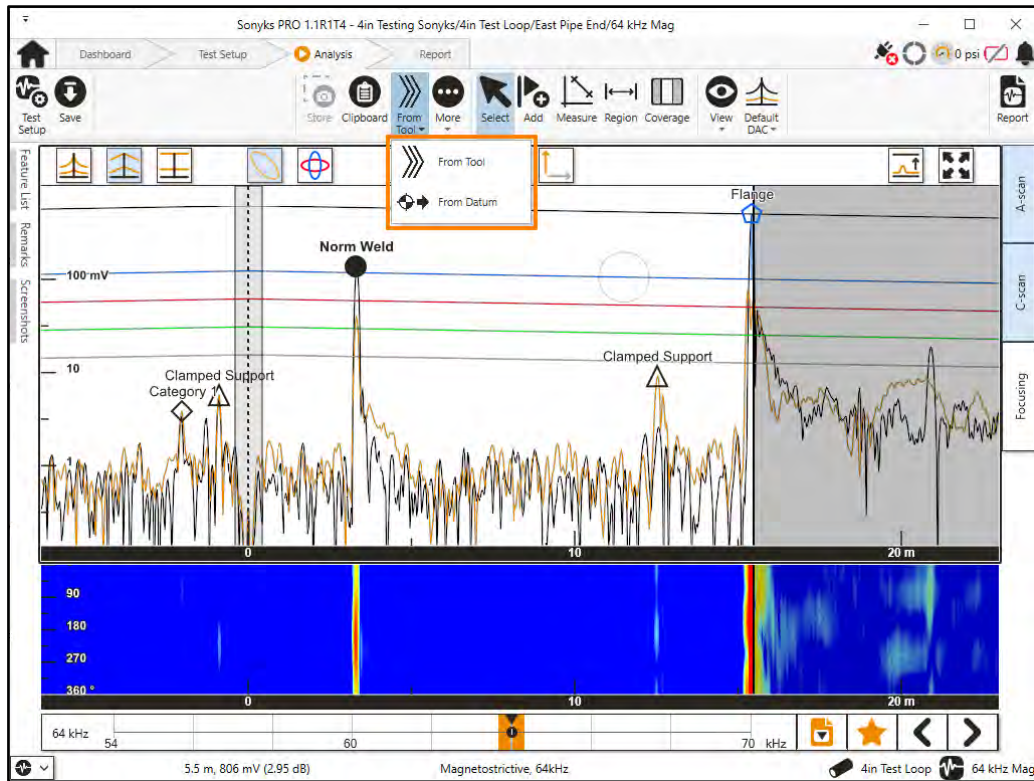

### 3.6.3 Frequency Slider

The frequency slider can be used to view the A-scan dynamically over the frequency range.

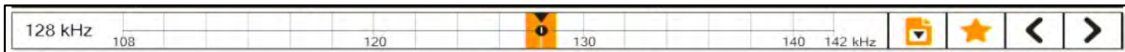

By default, the optimum test frequency for the test is highlighted in orange. The currently selected frequency is shown by the position of the black circular slider and is displayed in the box on the left-hand side of the slider bar. The frequency that will be used for reporting will be highlighted in orange with a black inverted triangle symbol. Frequencies of interest will be highlighted in orange.

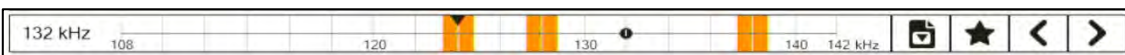

This button can be used to mark/unmark the reporting frequency.



This button can be used to mark/unmark frequencies of interest.

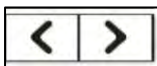

These buttons can be used to jump between marked frequencies of interest.

### 3.6.4 C-scan

The C-scan display can be switched on and off by clicking on the C-scan tab on the right-hand side. It displays an 'unrolled' view of the pipe with the x-axis as distance and the y-axis as circumferential position. The colours correspond to signal amplitudes, with warmer colours representing higher



amplitudes. As of the release of Sonyks 1.1, the angles of the unrolled view of the pipe show increments of 90°, between 0° and 360°, making circumferential position more intuitive.

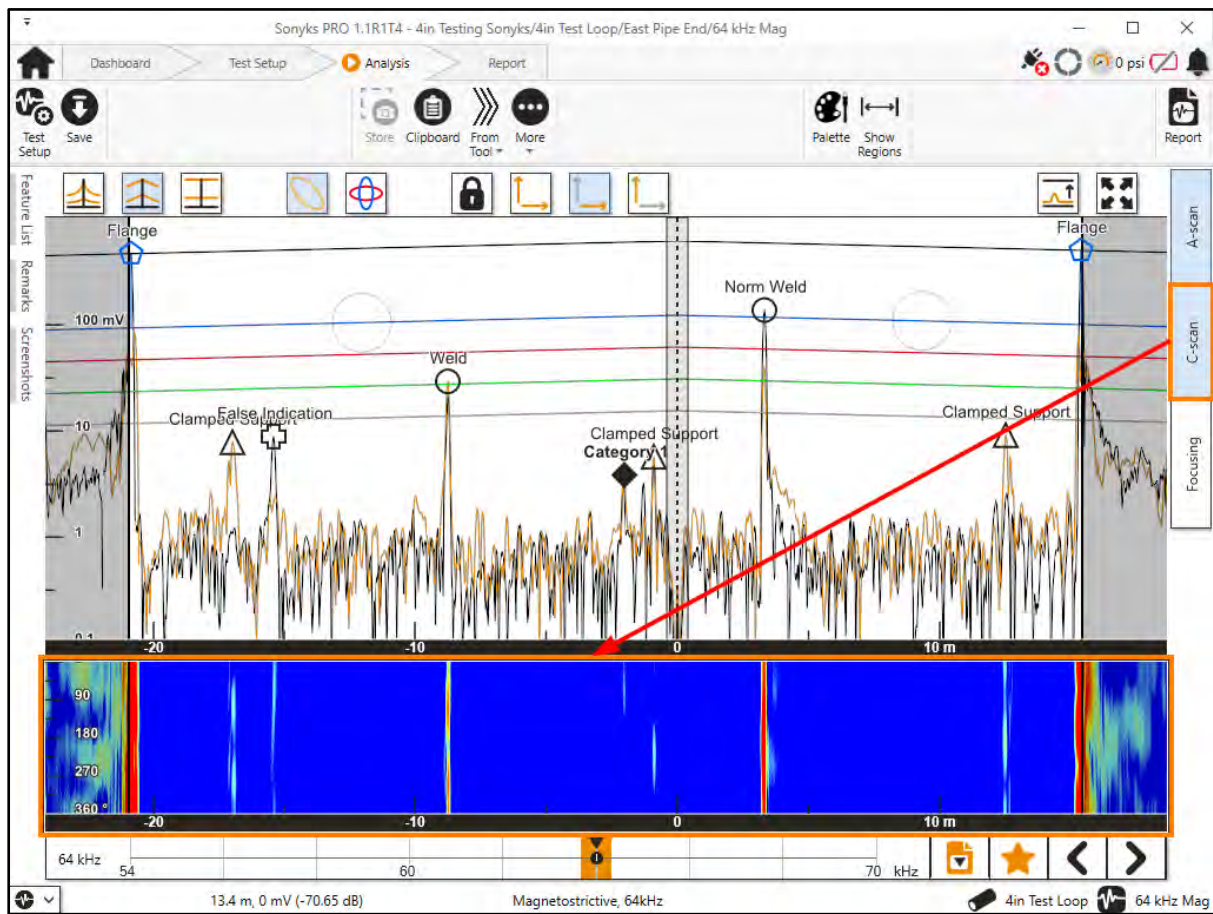

The following menus can be accessed by clicking on the C-scan image to make it the active view.

### 3.6.4.1 Palette

Adjust colour palette of the C-scan. The upper and lower thresholds values can be adjusted. Values in between will be colour coded accordingly.

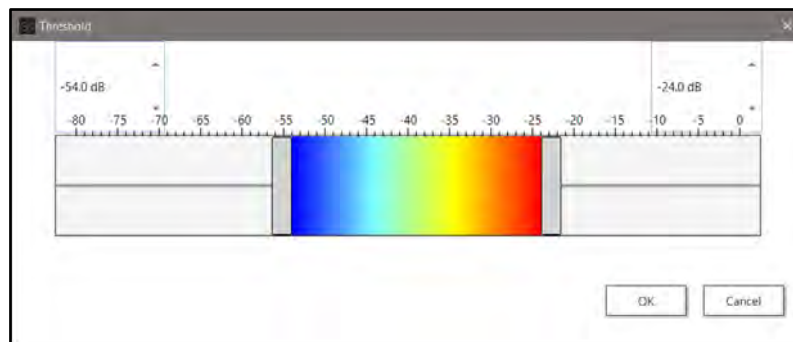

### 3.6.4.2 Show Regions

Show/hide dead zone and additional regions of interest on C-scan image.

### 3.6.5 Focusing

The Focusing display can be switched on and off by clicking on the Focusing tab on the right-hand side. Focusing can be performed at any point after the data acquisition stage and can be applied to any identified anomaly at any frequency.

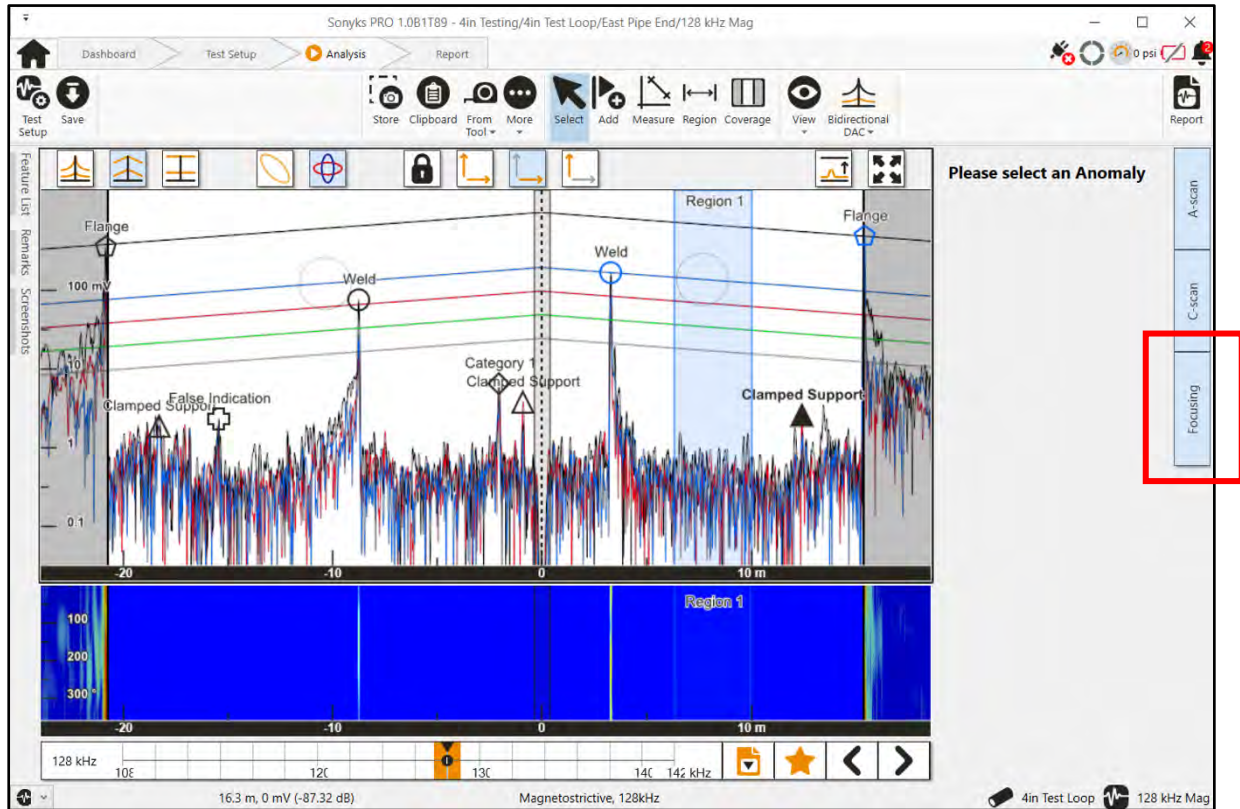

Selecting an anomalous indication will allow the frequency to be selected for focusing. The frequency of the currently displayed A-scan will be selected by default for focusing.

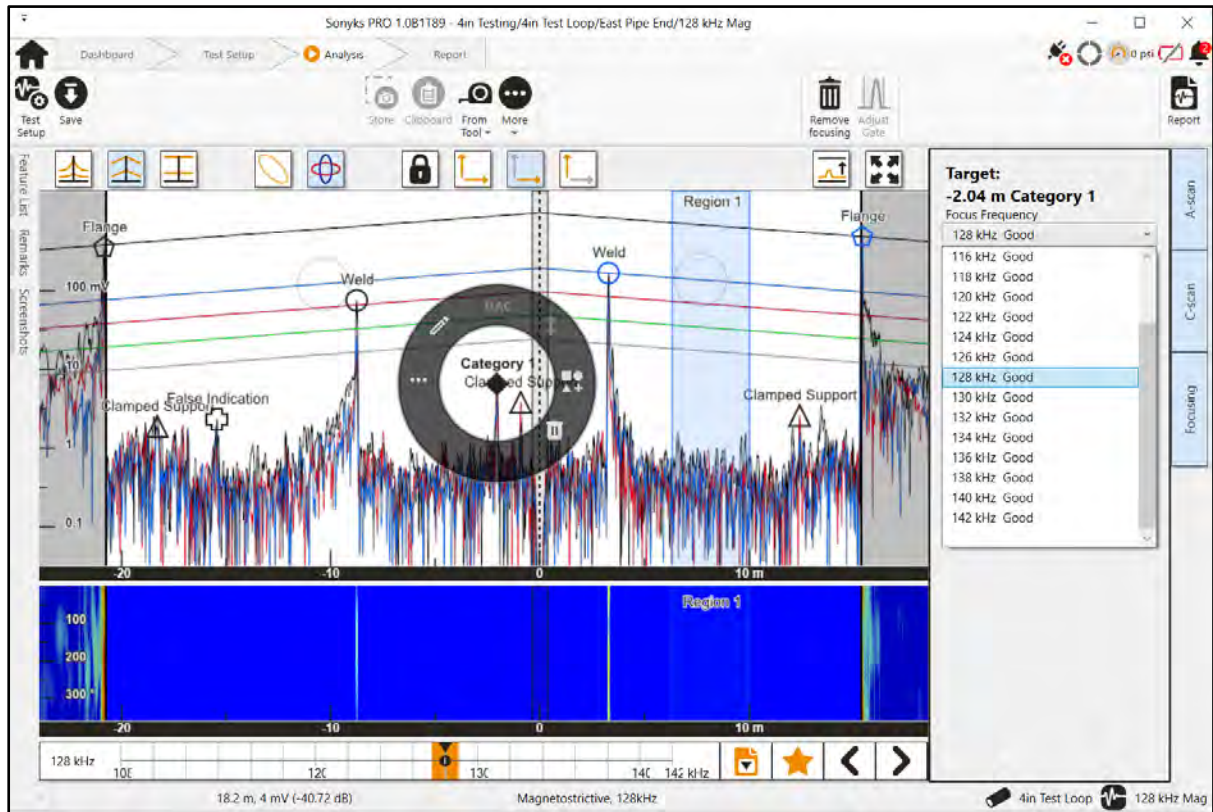

Once a frequency has been selected focusing can be performed by selecting the **Focus** button.

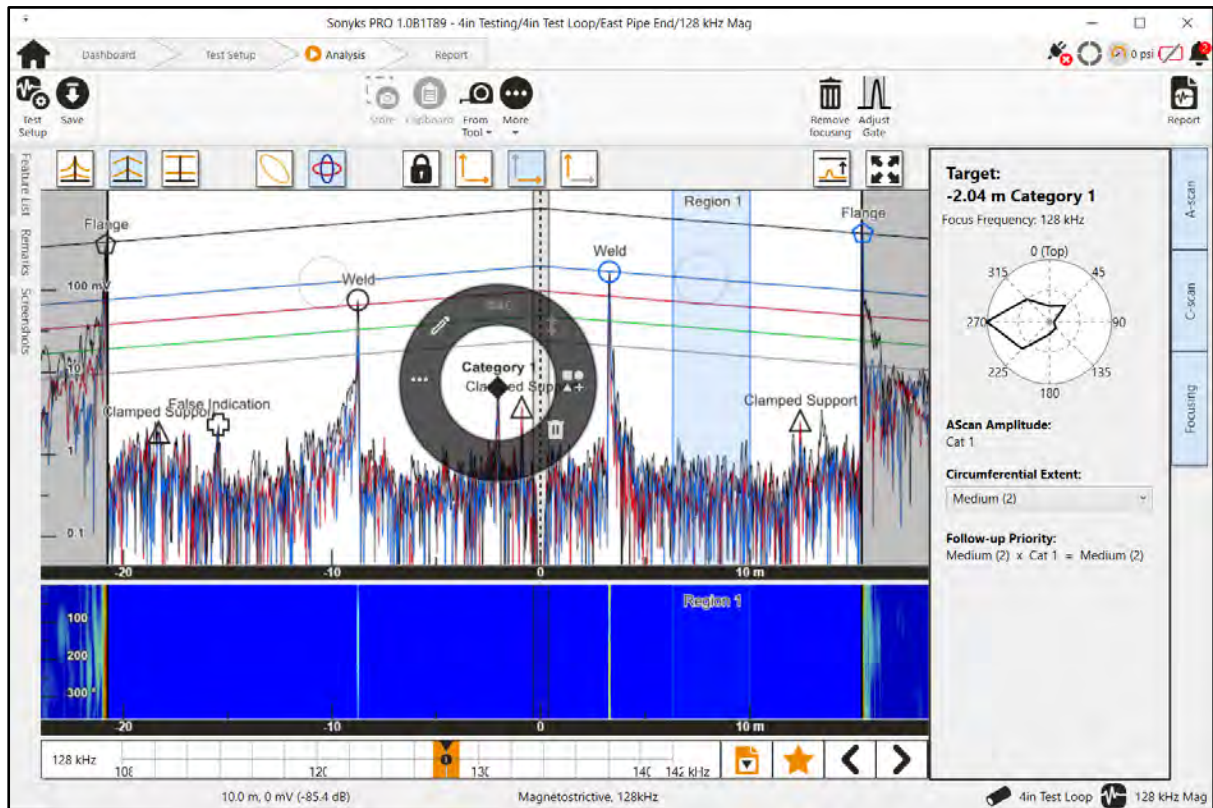



### 3.6.5.1 Adjust Gates

The start and end gates for the focused region can be adjusted by selecting the **Adjust gates** button on the main tool ribbon.

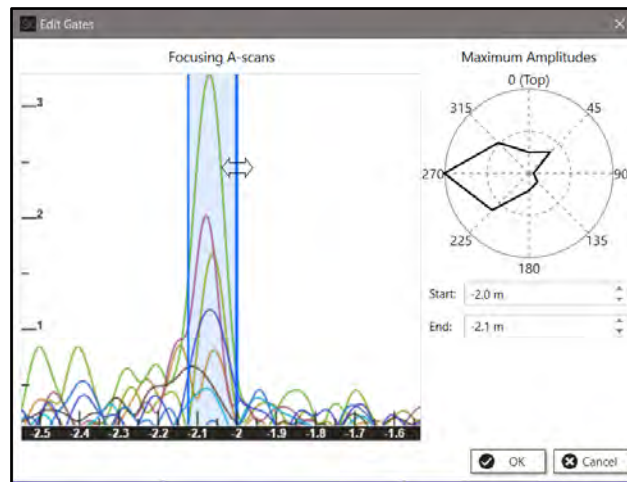

The position of the start & end gate can be adjusted by changing the values in the text boxes on the right, or by manually dragging the gate cursors on the A-scan.

### 3.6.5.2 Remove Focusing

Only one focus plot can be preserved per anomaly. Focusing at an alternative frequency can be performed by clicking the **Remove focusing** button on the menu ribbon and re-selecting a frequency for focusing.

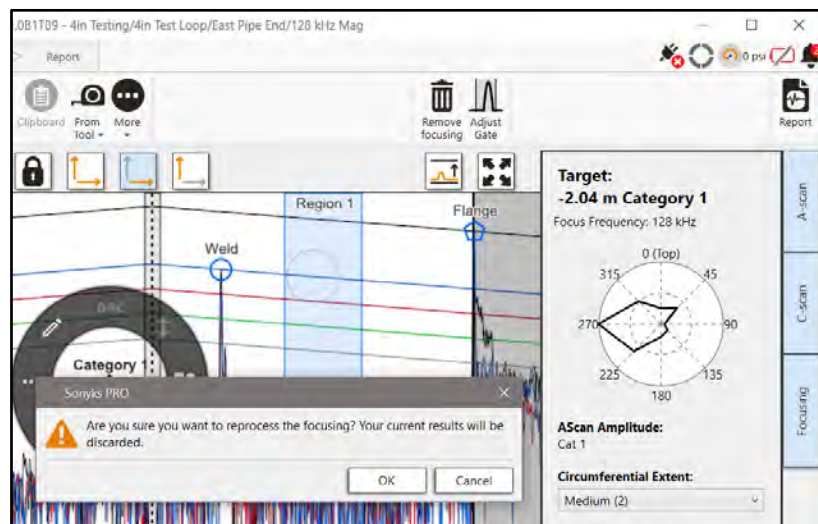

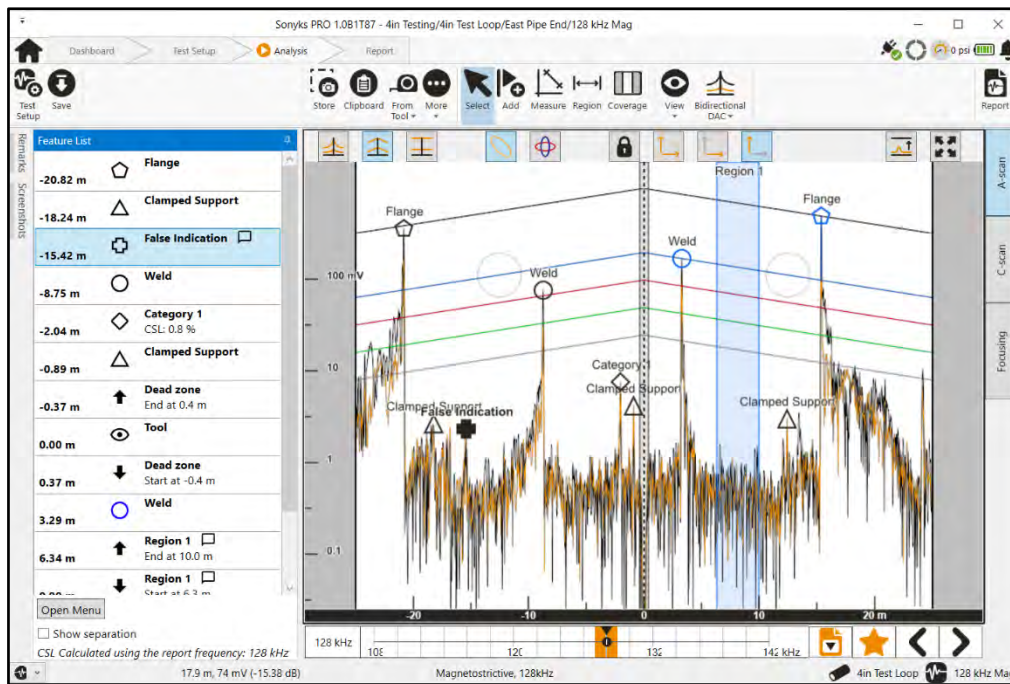

### 3.6.6 Feature List

The feature list can be viewed by clicking the feature list tab on the left of the screen.

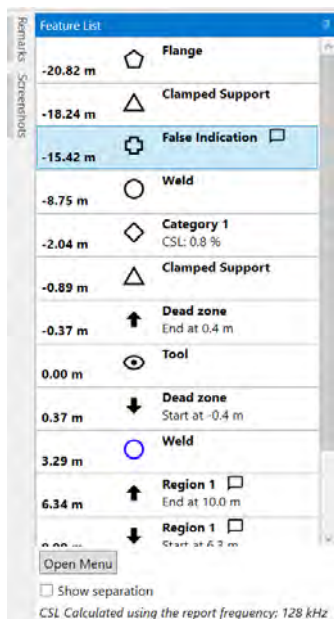

It can be anchored in position by clicking the pin icon in the top right-hand corner.



- The feature list contains information about all of the identified indications.
- The distance shown in each box is the distance relative to the datum/tool depending on what scale is being used on the A-scan.
- Regions (inc. dead zone) will show the distance at which the opposite end of the region exists, i.e., the start of region show end position on second line and vice versa.
- Anomalous indications will display the percentage cross-sectional loss (CSL).
- Features used for DAC construction will have blue icons.
- Features with a  icon have additional comments attached to that feature.

If the “Show Separation” box is checked, a second distance show above the main distance. The distance after the Δ is the distance from the previous feature.

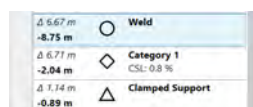

### 3.6.7 Remarks

This is a text box to record findings, conclusions, and general observations.

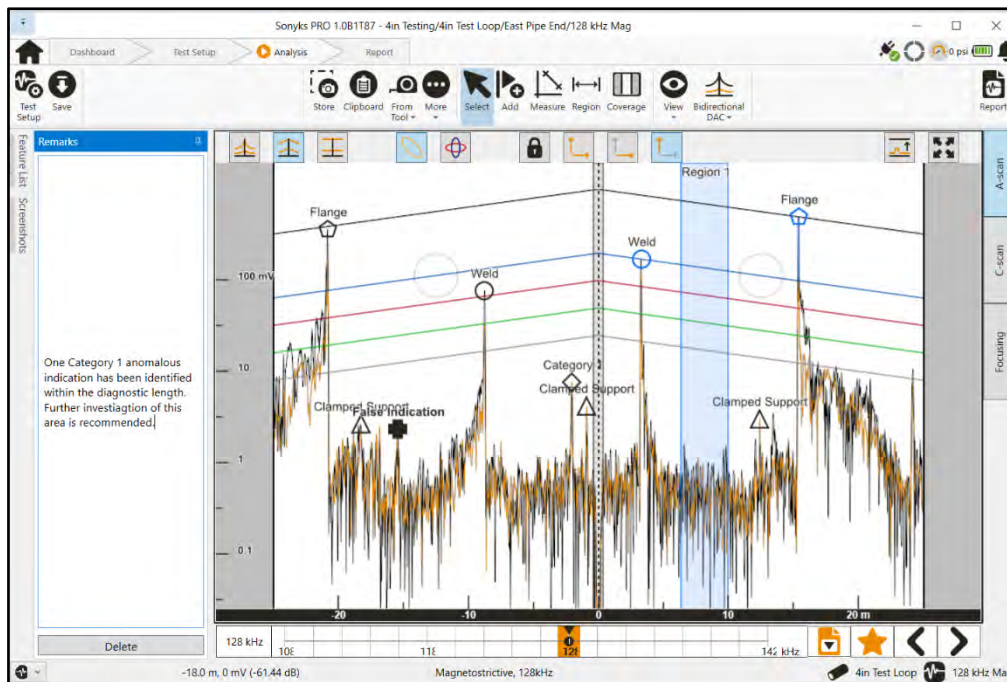

It can be anchored in position by clicking the pin icon in the top right-hand corner.

### 3.6.8 Screenshots

Screenshots can be added to the report in addition to the main A-scan image to highlight a specific feature(s). To capture a screenshot, click the **Store** button on the toolbar. This will capture an image of the active A-scan and C-scan in its current configuration, i.e., zoomed in on a region of interest. The Store function is only active if the distance is displayed with respect to the datum position.

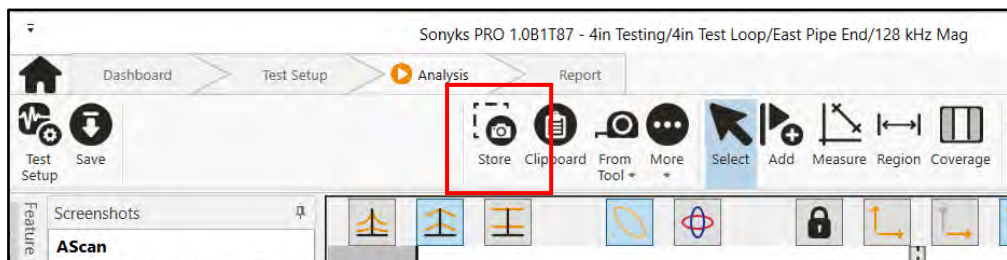

In the Sonyks PRO (PC version), the screenshot images can be captured to the Clipboard and subsequently pasted into external programs, i.e., Word, Paint, etc. The Clipboard function can capture images where the distance is shown with respect to the datum position and with respect to the tool position.

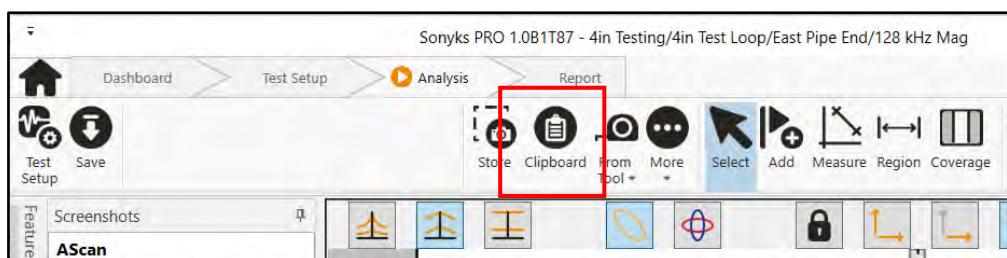



The screenshot tab contains a list of all the stored screenshots.

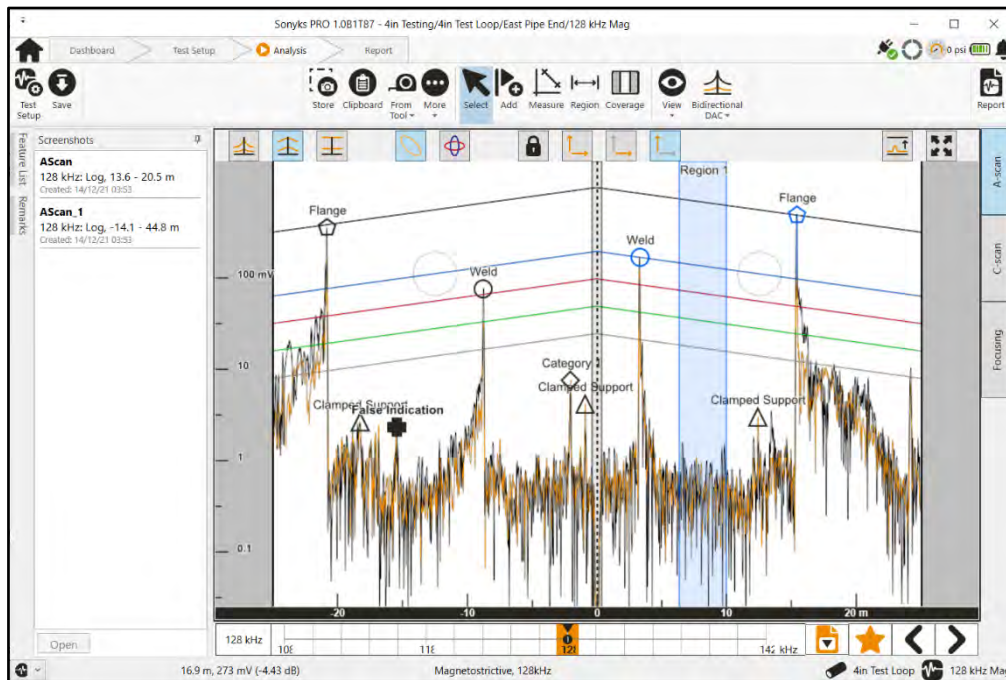

It can be anchored in position by clicking the pin icon in the top right-hand corner.

### 3.6.9 Keyboard Shortcuts

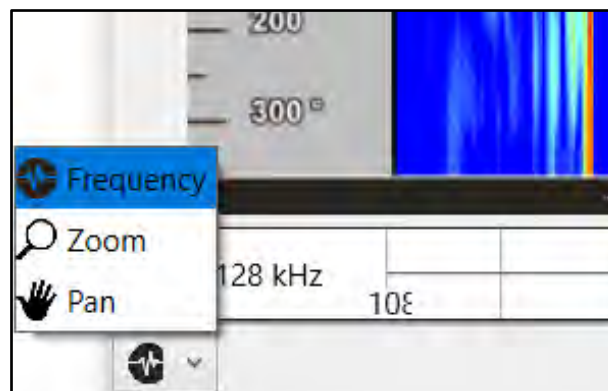

The keyboard shortcuts menu is designed to aid in analysis by assigning the functions of the keyboard arrow keys. The keyboard shortcuts menu can be found in the bottom left-hand corner.

1. **Frequency:** This sets the arrow keys to control the function of the frequency slider. The Left & Right arrows will adjust the slider to move through the available frequency range. The Up & Down arrow keys will jump between bookmarked frequencies.
2. **Zoom:** This sets the arrow keys to control the zooming function. The Left & Right arrows will adjust the zoom level of the x-axis. The Up & Down arrow keys will adjust the zoom level of the y-axis. All zooming will be centred around the centre of the screen.
3. **Pan:** This sets the arrow keys to control the panning function. The Left & Right arrows will pan the A-scan in the left and right directions respectively. The Up & Down arrow keys will pan the A-scan in the up and down directions respectively.



**NOTE:** The shortcuts are contextual, this list will adapt to functionality selected from the main menu ribbon.

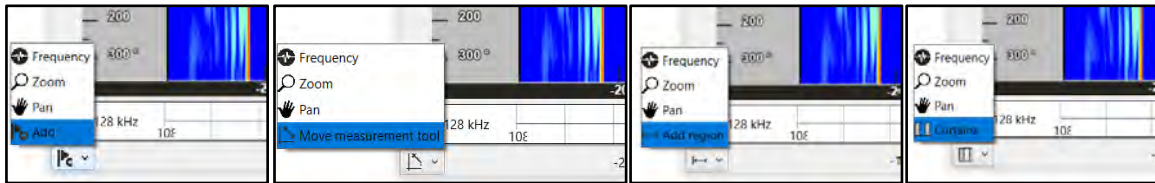

4. **Add:** This sets the arrow keys to control the add features function. The Left & Right arrows will move the cursor in the left and right directions respectively. The cursor will jump from peak to peak (symmetric or flexural depending on the selected mode) in the selected direction. Hitting the Enter key will add the currently selected feature.
5. **Move measurement tool:** This sets the arrow keys to control the measurement tool. The Left & Right arrows will pan the selected node of the measurement tool in the left and right directions respectively. The Up & Down arrow keys will pan selected node of the measurement tool in the up and down directions respectively. The Enter key can be used to switch the selected node.
6. **Add region:** This sets the arrow keys to control the add region function. The Left & Right arrows will pan the add region function cursor in the left and right directions respectively. Hitting the Enter key will add the first point of the region. The Left & Right keys can then be used to select a region. Hitting the Enter key a second time will add the second point of the region.
7. **Curtains:** This sets the arrow keys to control the coverage cursors. The Left & Right arrows will pan the coverage cursors in the left and right directions respectively. The Enter key can be used to switch the selected cursor.

## 3.7 Reporting

### 3.7.1 Test Reports

Test reports can be generated from the analysis screen by selecting the **Report** button.

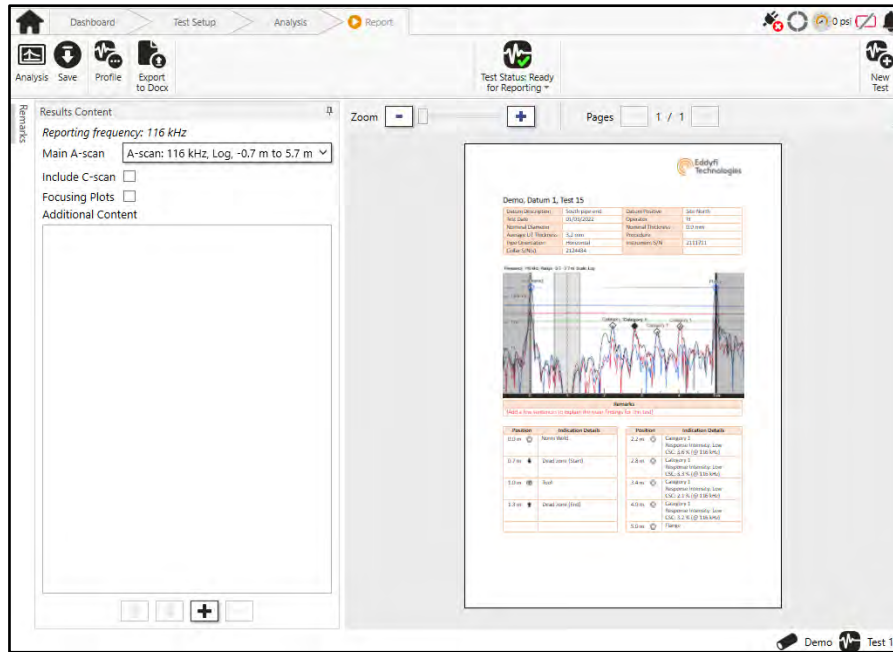

#### 3.7.1.1 Profiles

The report content is controlled by report profiles. The profiles can be edited and saved for specific applications.

##### 3.7.1.1.1 Test

The default items for this tab are selected, but all available information is shown in the report extract.

Test Report Profile Editor

Test | Pipe | Datum | Equipment

Operator

Site

Client

Procedure

Test Date	01/03/2022	Operator	AJ
Site	Linton	Client	Eddyfi
Procedure	GWT-001		

Default | Recent | Import | Export |  OK |  Cancel

### 3.7.1.1.2 Pipe

The default items for this tab are selected, but all available information is shown in the report extract.

Test Date	01/03/2022	Nominal Diameter	
Nominal Thickness	0.0 mm	Average UT Thickness	3.2 mm
Material	Aluminum (6061-T-6)	Standard	None
All UT Thicknesses	0° : 3.2 mm, 90° : 3.2 mm, 180° : 3.2 mm, 270° : 3.2 mm	Pipe Orientation	Horizontal
Surface Temperature	Not given		

### 3.7.1.1.3 Datum

The default items for this tab are selected, but all available information is shown in the report extract.

Datum Description	South pipe end	Datum Positive	Site North
Test Date	01/03/2022	Circumferential Origin	Top
GPS Position	52.1 °, 0.3 °		

### 3.7.1.1.4 Equipment

The default items for this tab are selected, but all available information is shown in the report extract.

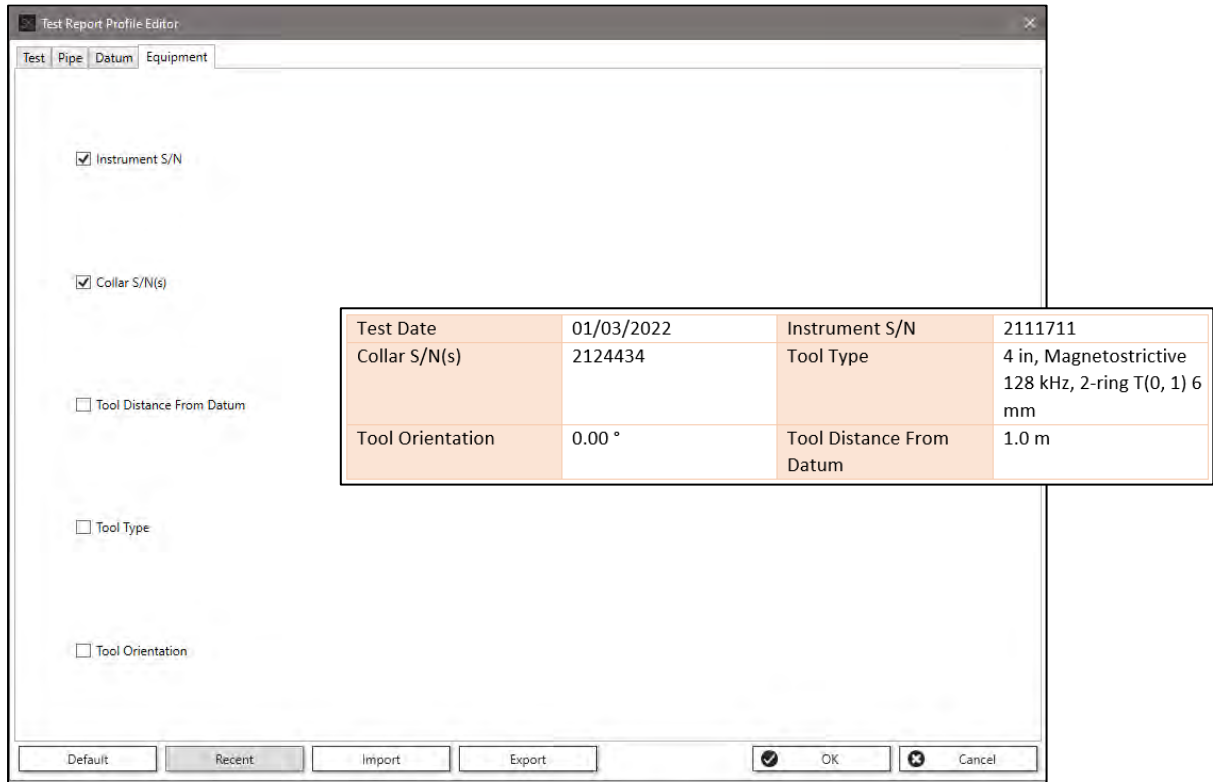

### 3.7.1.1.5 Import/Export

Profiles can be saved (**Export**) or loaded (**Import**). When multiple profiles exist, they can be selected quickly from the **Recent** button. The image below shows the Sonyks GO (embedded) menu, in Sonyks PRO (PC version) the Windows Explorer dialogue will open instead.

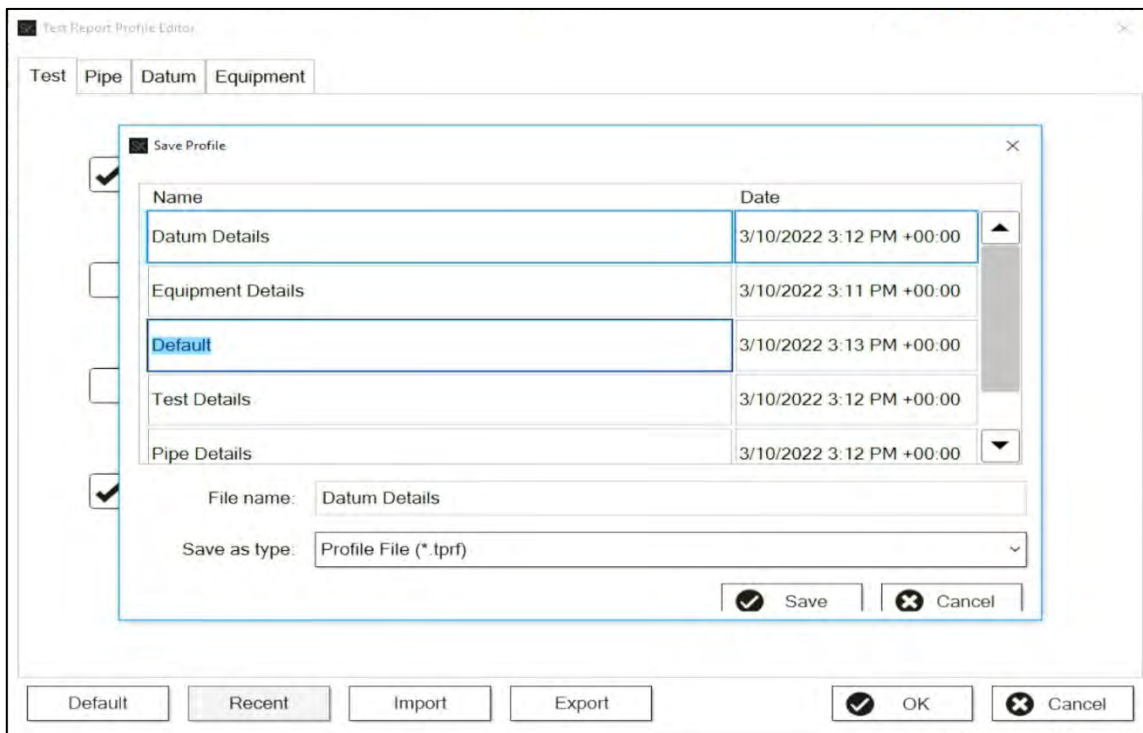

### 3.7.1.2 Export to Docx

This feature allows exports of reports generated as a Microsoft Word document.

In Sonyks GO (embedded version), the Word file can be copied to the USB using the transfer function. Exporting the test file to USB will also export any Test Reports associated with that test file. The reports use the following filename format: TESTNAME-YYYY-MM-DD--hh-mm-ss.docx. The export can be done either at the Report stage in the software or from the Explorer screen. A 'Word Files' icon is visible on the Explorer screen with a green overlay that indicates the number of Word files that are available for export. The Explorer screen option gives the user the opportunity to select a specific report for export to USB. If no USB is detected on the instrument, then an error will be displayed, and export will not be possible.

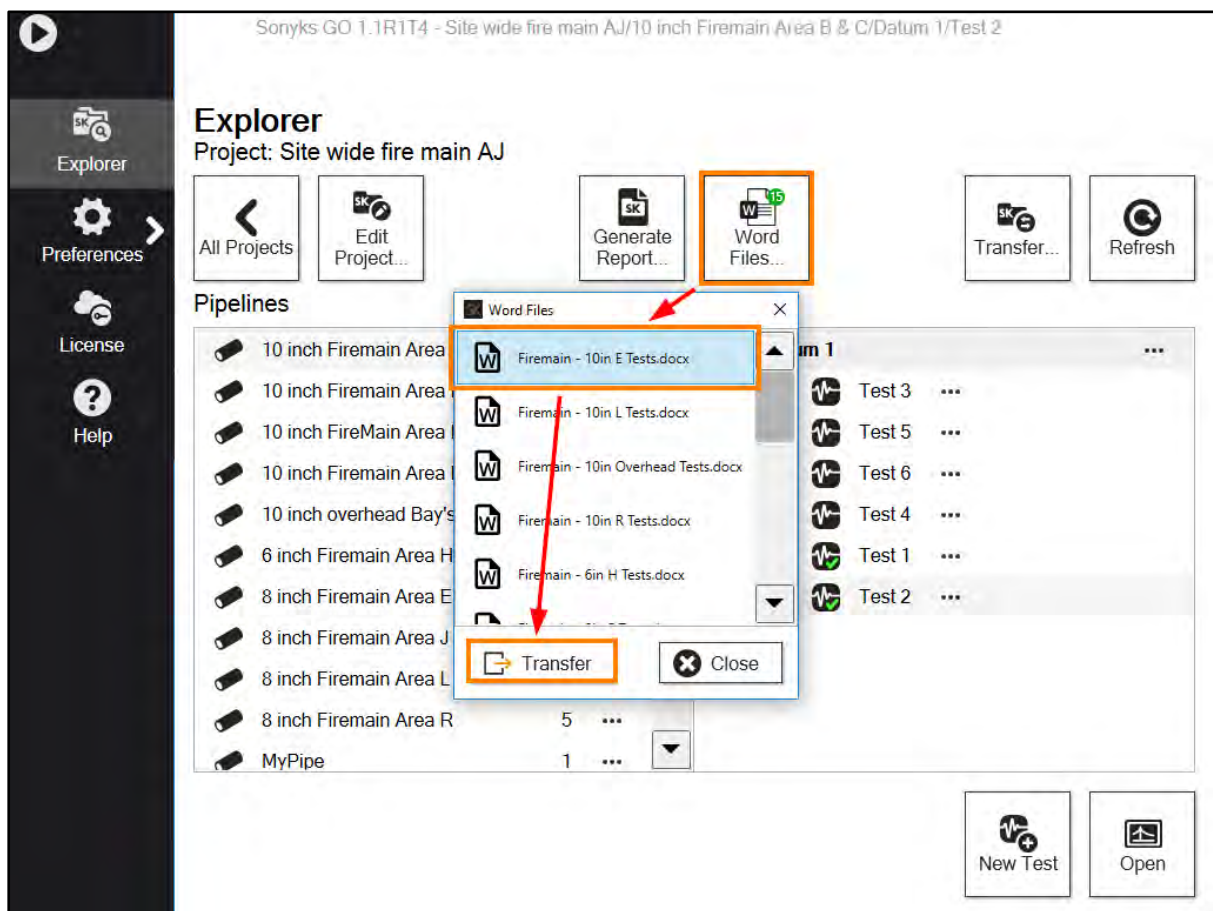

In Sonyks PRO (PC version), the word file will be exported using the Windows File Explorer through which the filename and directory can be chosen for the exported Word version of the report.

### 3.7.1.3 Test Status

This marks the current status of the report. The Test Status is used for compiling Project Reports.

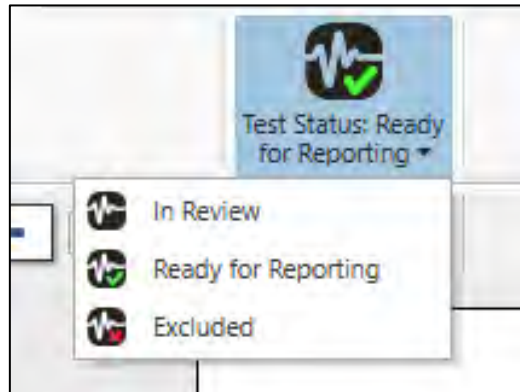

1. In Review: This means that the data is still being analysed and the test is not ready for reporting.
2. Ready for Reporting: This means that all analysis for this test has been completed, and the report content for the Test Report has been generated and included.
3. Excluded: This means that this test will not be included in the Project Report, even if a Test Report has been exported.

### 3.7.1.4 Main A-scan

The main A-scan is the first A-scan image in the report. Typically, this will be the A-scan that shows the full diagnostic range and all identified features. The main A-scan can only be selected from the Reported Frequency and will always show the distance with respect to the datum position. It is possible to generate A-scans for several different distance ranges. The dropdown list will show what A-scan images are available.

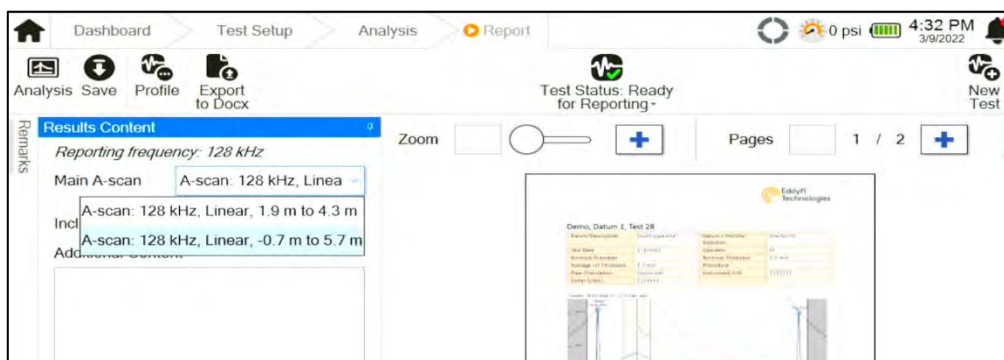

### 3.7.1.5 Include C-scan

If the Include C-scan option is selected the C-scan image will be placed directly below the A-scan. If the C-scan was not active on the Analysis screen, then this option will be greyed out.

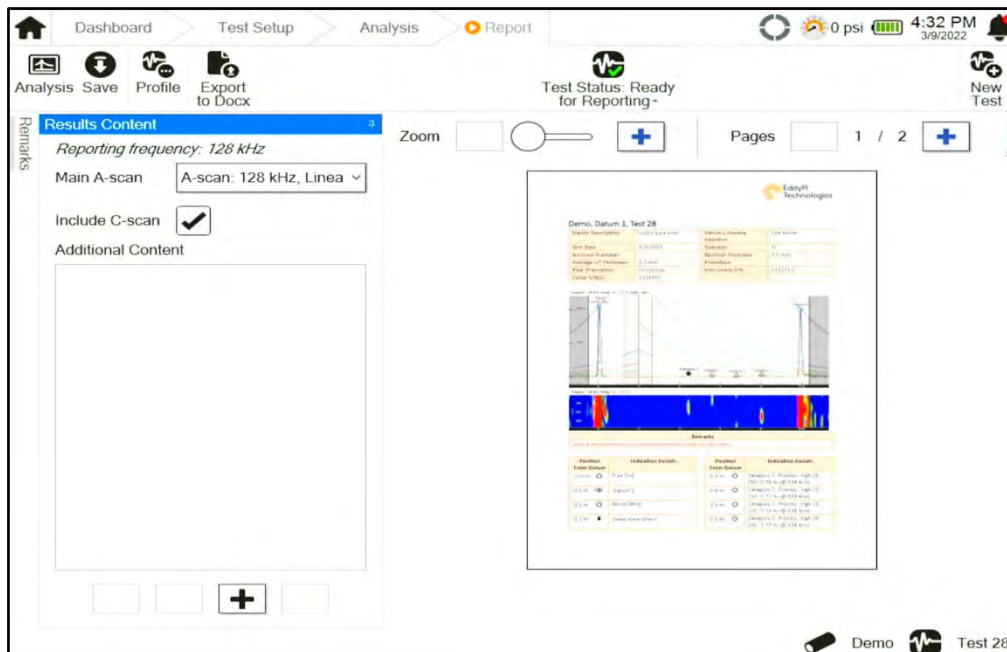

### 3.7.1.6 Focusing Plots

If the Focusing Plots option is selected the focus plots will be placed in a table below the Results. If no focus plots were produced, then this option will not be shown.

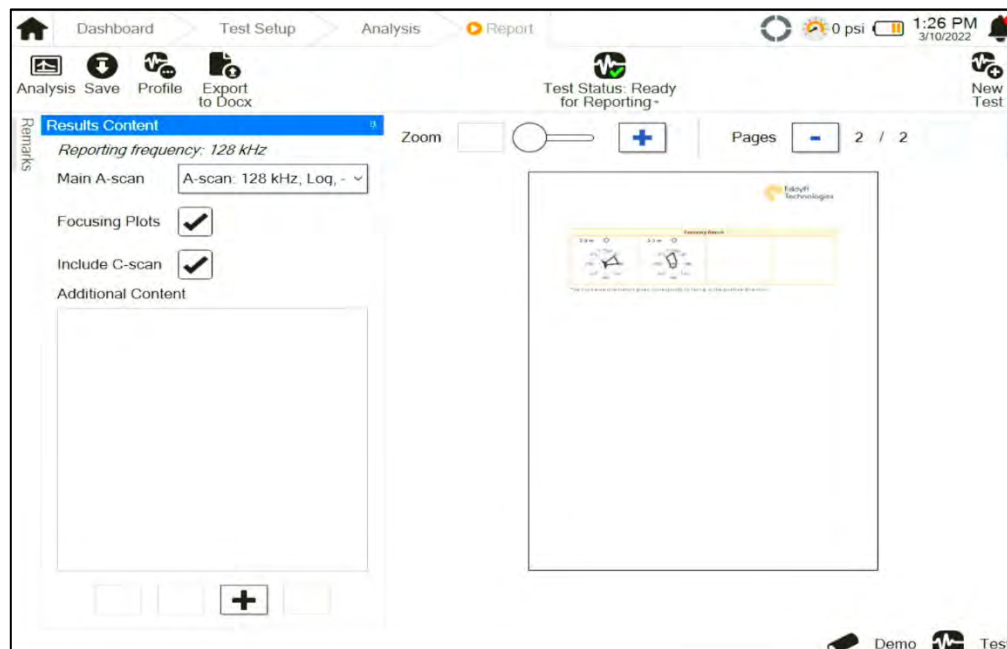

### 3.7.1.7 Additional Content

Additional content can be added to the basic report. The additional content may be extra A-scan or C-scan views, or additional frequencies that have been capture using the Store function. Pressing the + button below the additional content window will allow you to browse through any existing



additional content for the selected test file. Additional content will be placed below the focusing plots (if included).

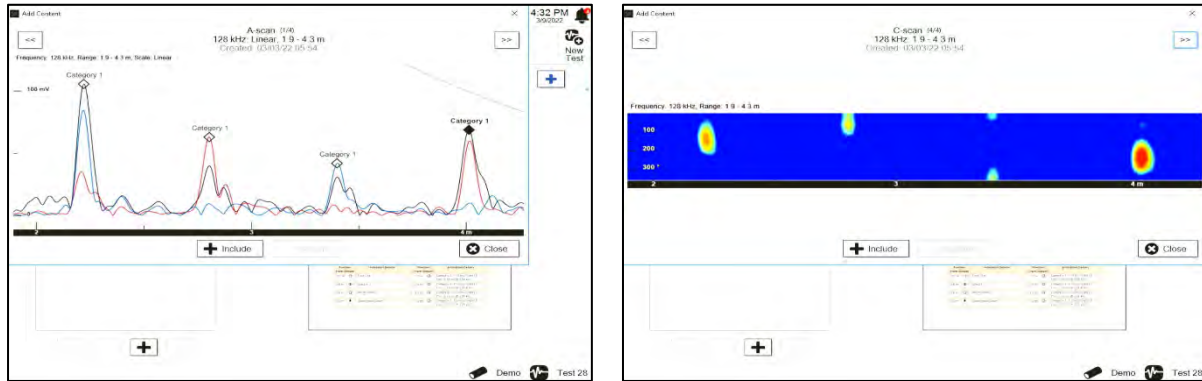

The additional content will be shown in the Additional Content window, and its presentation order can be adjusted using the up and down arrows.

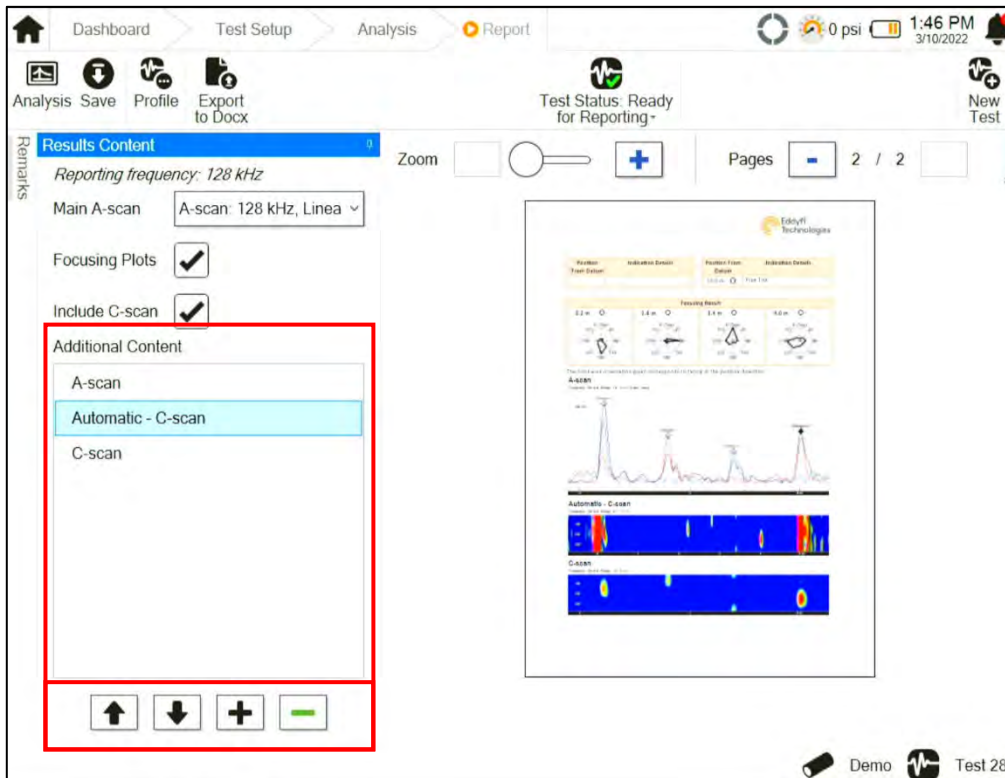

Additional content can be removed by highlighting the content and clicking on the - button, or by selecting Exclude from the browser window.

### 3.7.2 Project Reports

Project reports can be generated from the explorer screen by opening the project to be reported and clicking on the **Generate Report** button.

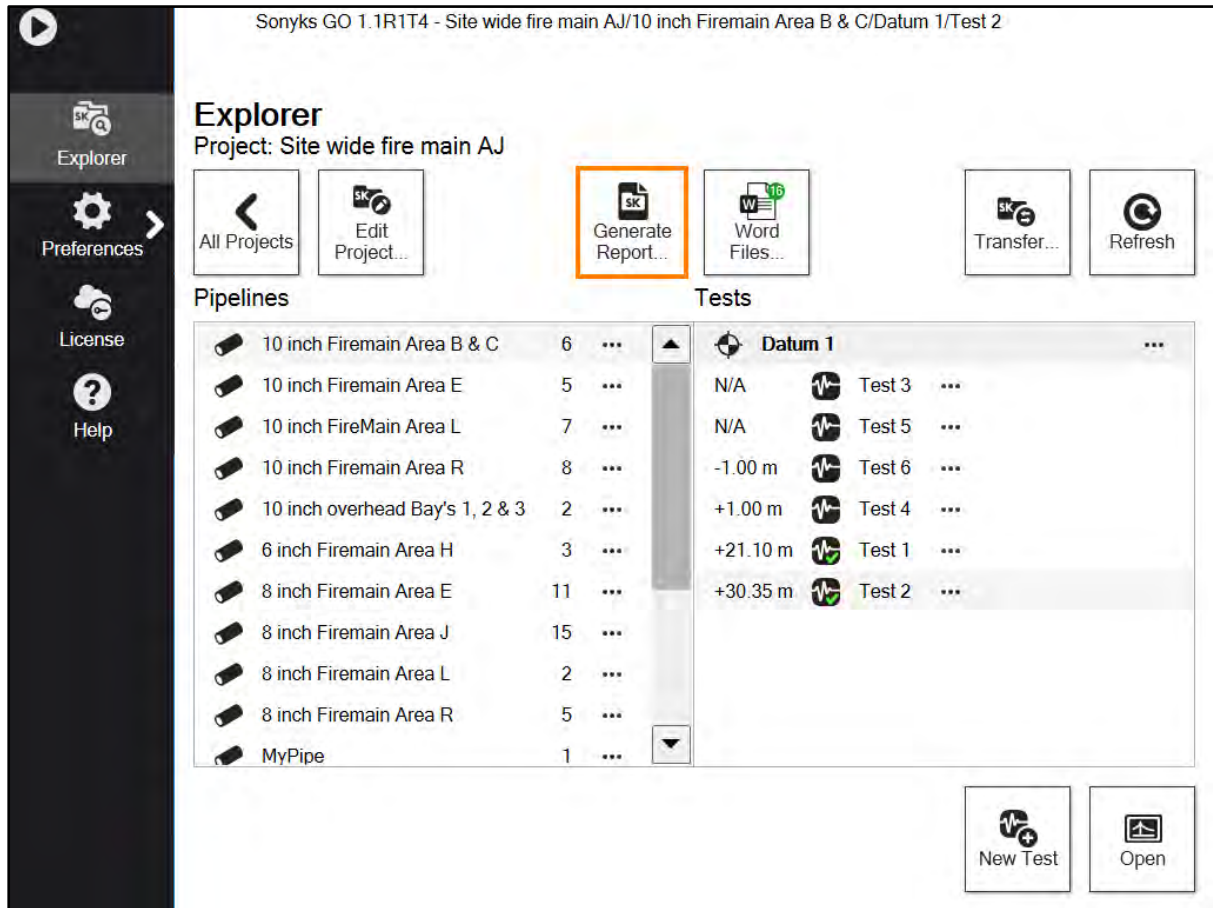

#### 3.7.2.1 Contents Menu

The contents menu is a list of content that can be included within the project report. This view is slightly different for the Sonyks GO (embedded version) and the Sonyks PRO (PC version), as shown below.

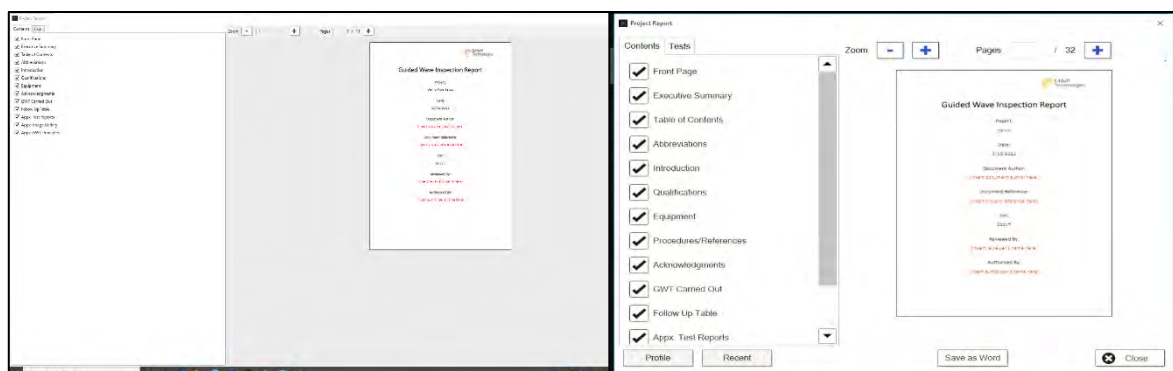

#### 3.7.2.1.1 Front Page

This is the Title or Cover Page on the report. It will have the Project Name, Date and Client entered automatically. There are additional fields for manual entry of **Document Author**, **Document Reference**, **Reviewer** and **Authoriser**.

#### 3.7.2.1.2 Executive Summary

This will display an automatically generated record of the number of pipelines tested, the number of tests performed, and the total number of anomalous indications identified in both text format and tabulated form.

#### 3.7.2.1.3 Table of Contents

This is a table of contents listing the various chapter included in the report. If the report is manually edited, is recommended that this table of contents is replaced with a dynamic table of contents. Instruction on how to do this is included in the contents page.

#### 3.7.2.1.4 Abbreviations

This is a table of commonly used abbreviations and definitions used in the report.

#### 3.7.2.1.5 Introduction

This is an automatically generated paragraph of text containing the test dates, site location and client. There is an additional filed for entering **additional relevant contractual document references**.

#### 3.7.2.1.6 Qualifications

This is a table with manual fields for entering information relevant to the **Inspectors and Reviewers qualifications**.

#### 3.7.2.1.7 Equipment

This is an automatically generated table of the equipment used to collect the data and generate the report. Serial numbers, where recorded, are included. Additional rows can be added to record the **details of ancillary test equipment**.

#### 3.7.2.1.8 Procedures/References

This is an automatically generated paragraph of text referencing Eddyfi Technologies relevant GWT inspection procedures and work instructions. It should be manually edited to include company specific procedures as appropriate.

#### 3.7.2.1.9 Acknowledgements

**This is a place holder paragraph for acknowledgements.** It should be manually edited to reference those that provided assistance during the inspection.

### 3.7.2.1.10 GWT Caried Out

This is an automatically generated table of inspection coverage achieved during the inspection. A table will be generated for each datum position on each pipe inspected. The table will contain information on the diagnostic range achieved, along with any excluded zones within that range. The diagnostic ranges of all tests performed in this section will also be graphically represented, as shown below.

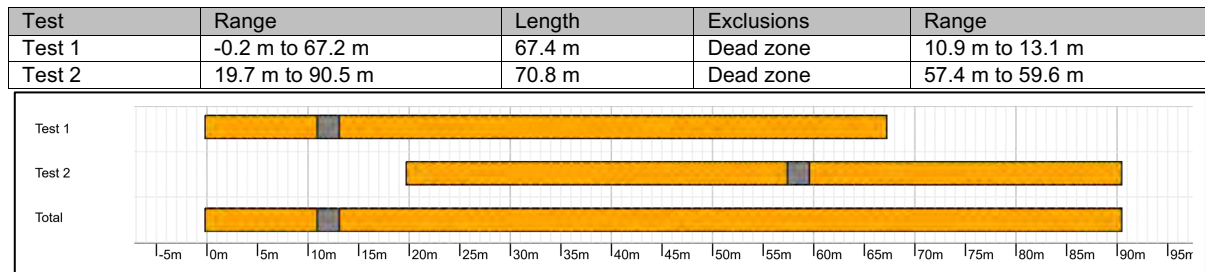

### 3.7.2.1.11 Follow Up Table

This is an automatically generated table of all anomalies identified within the project. It contains information on the anomalies position, estimated cross-sectional loss, circumferential distribution, and the response intensity. There is a column for additional comments regarding this anomaly.

Pipeline, Datum, Test	Position from Datum	Estimated Cross-Section Area Loss	Circumferential Response	Response Intensity	Comment
<b>Pipe 1, Datum 1, Test 1</b> Datum: Datum 1 Positive From Datum: South pipe end	2.3 m	2.75 %	Narrow	High	
<b>Pipe1, Datum 1, Test 2</b> Datum: Datum 1 Positive From Datum: South pipe end	22.9 m	2.82 %	Wide	Low	

### 3.7.2.1.12 Appx: Test Reports

These are the automatically generated Test Reports, and they display the test data. The format for each report will depend on the format used to configure the test report in each case – See 3.7.1 Test Reports.

### 3.7.2.1.13 Appx: Image Gallery

This contains place holders for any relevant images, such as photographs of the tool location, identified anomalies or datum features.

#### 3.7.2.1.14 Appx: GWT Principles

This is an automated chapter of text. It contains information on the technique, principles of operation and interpretation. It is designed to assist the reader in understanding the report contents and findings.

Chapter 4

# Magneto and piezo Tooling



## 4. Magneto and Piezo Transducer Tooling

The Sonyks product is unique on the market as it has the capability to use 2 different types of transducer tooling, either Piezo-tooling or magneto-tooling. The piezo-tooling uses piezoelectric transducers to induce the sound into the pipe and is similar to what has been used for many years for Guided Wave Testing. Magneto-tooling is new for this product and is slightly different in how it operates compared to piezo tooling.

### 4.1 Sonyks Piezo Tooling

The piezo tooling has a single tool lead connector. These tools are divided into circumferential segments, the number of which are dependent upon their size. However, the configuration will be automatically loaded into the software upon connection.

- They are rated for an inflation pressure of 60psi.
- Temperature rating up to 120°C (248°F).
- The collars contain accelerometers to enable automatic recording of circumferential orientation (horizontal pipe work only).



#### 4.1.1 Transducers



The Teletest transducers use a D51 PZT element that has a shear displacement along its length. The element is mounted in a stainless-steel backing block with a ceramic wear plate coupling surface.

The transducers are designed to operate in the temperature range of 0°C to 120°C (32°F to 248°F). Each transducer is marked with a unique alphanumeric serial number.

#### 4.1.2 Piezo modules



The transducer modules contain two transducers with a 17mm ring spacing. There are buttons on each end to enable the module to be released from the collar. The buttons are coloured black and white to indicate the modules polarity. The connectors are also polarised so that the modules cannot be fitted with an incorrect orientation.

##### 4.1.2.1 Installing and removing transducers from the module

To install a transducer into the module, align the transducer connector with the connector in the module. Gently push the transducer into the module slot until you feel it engage.

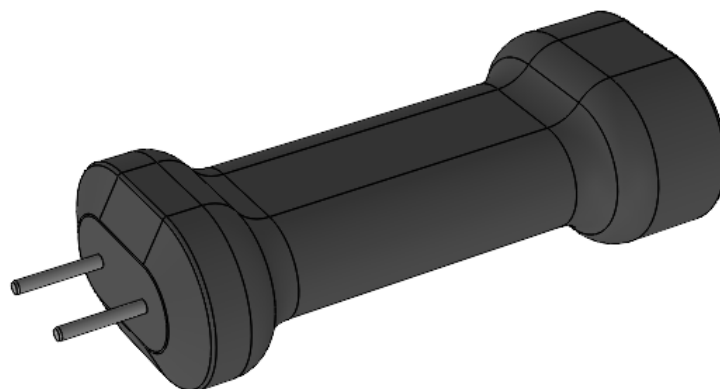

To remove a transducer from the module, insert the transducer removal tool into the two holes on the top side of the module. Push until the transducer disengages from the module.

##### 4.1.2.2 Attaching the modules to the collar

To fit the module into the collar, align the module so that the end with the white button is on the side of the collar with the metal connectors. Support the collar connector from beneath with your

fingers and gently press on the module until the button clicks, locking the module into place. Repeat this process on the other end of the module.

To remove the module from the collar, depress the buttons on each end of the module and lift it out of position.

### 4.1.3 Attaching and inflating the collar

#### 4.1.3.1 Precautions

- The collar webbing should be periodically inspected for damage.
- Particular attention should be paid to the stitching in the area around the air valve.
- Check the edges of the webbing for nicks or tears.
- Check the ends of the webbing for signs of fraying.
- If there is evidence of any of the above, consult with Eddyfi before using the collar.
- Do not overinflate.
- Do not operate the collar with missing modules.

#### 4.1.3.2 Attaching the Buckle

Follow these instructions to attach the buckle to the strap.

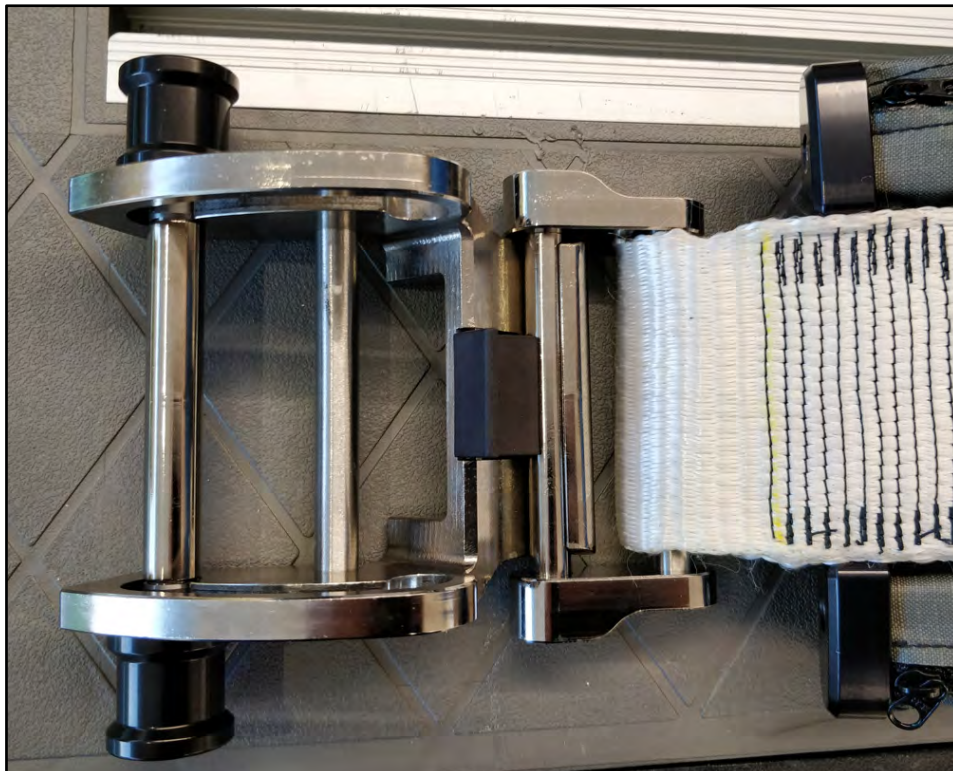

1. Pass the strap behind the 2 bars, from underneath the buckle.



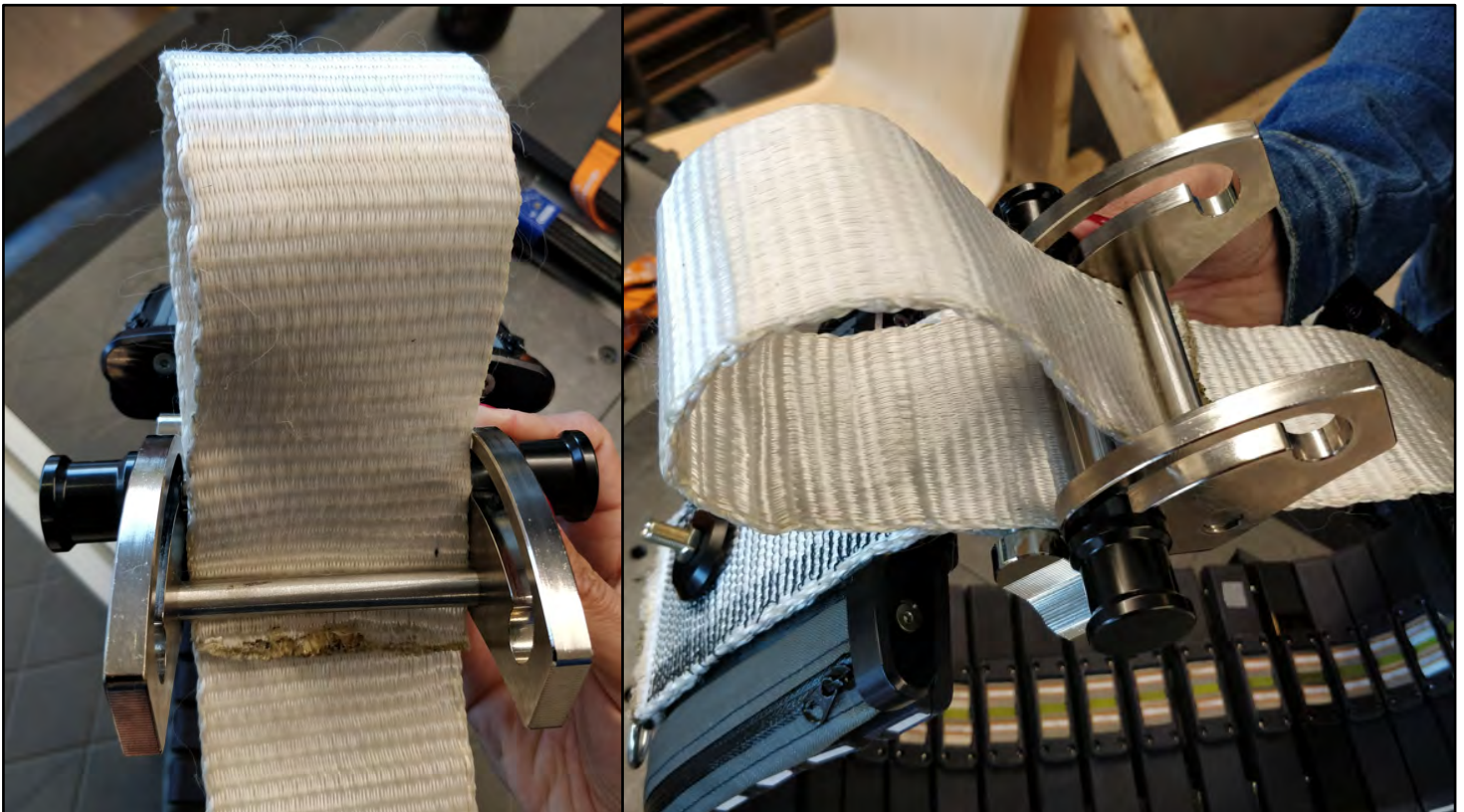
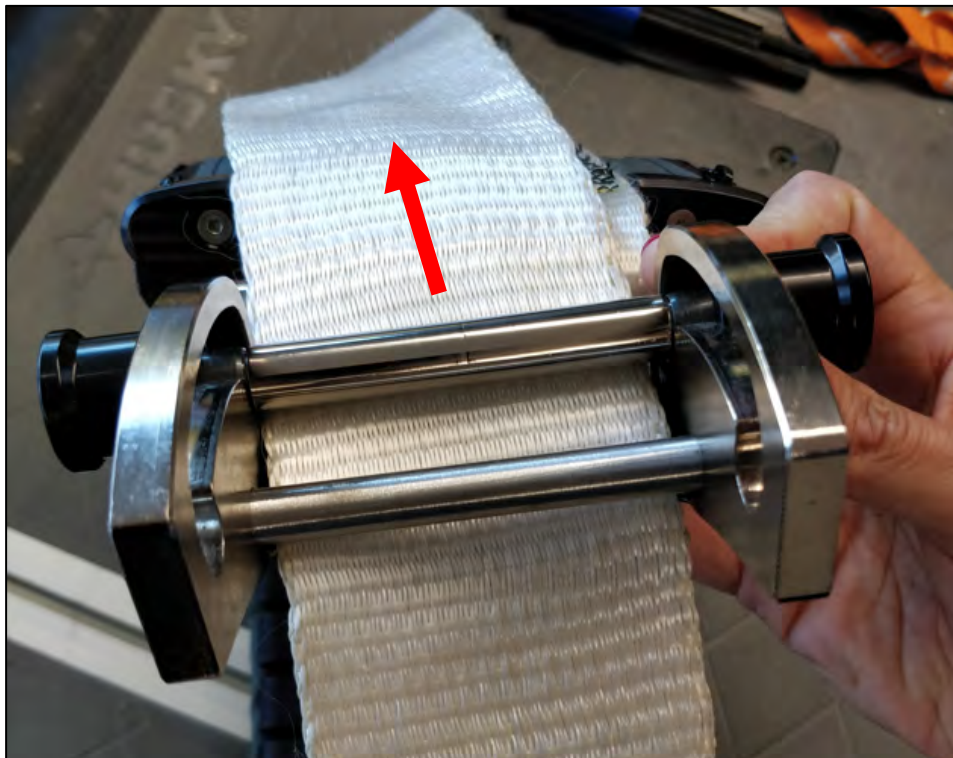

2. Fold the strap and pass it between the 2 bars (in front of the back one, behind the 2nd one).
3. Pull on the strap so it is secured in the buckle.



### 4.1.3.3 Installing the collar

1. Unclip the large part of the buckle, using the black plastic latch.

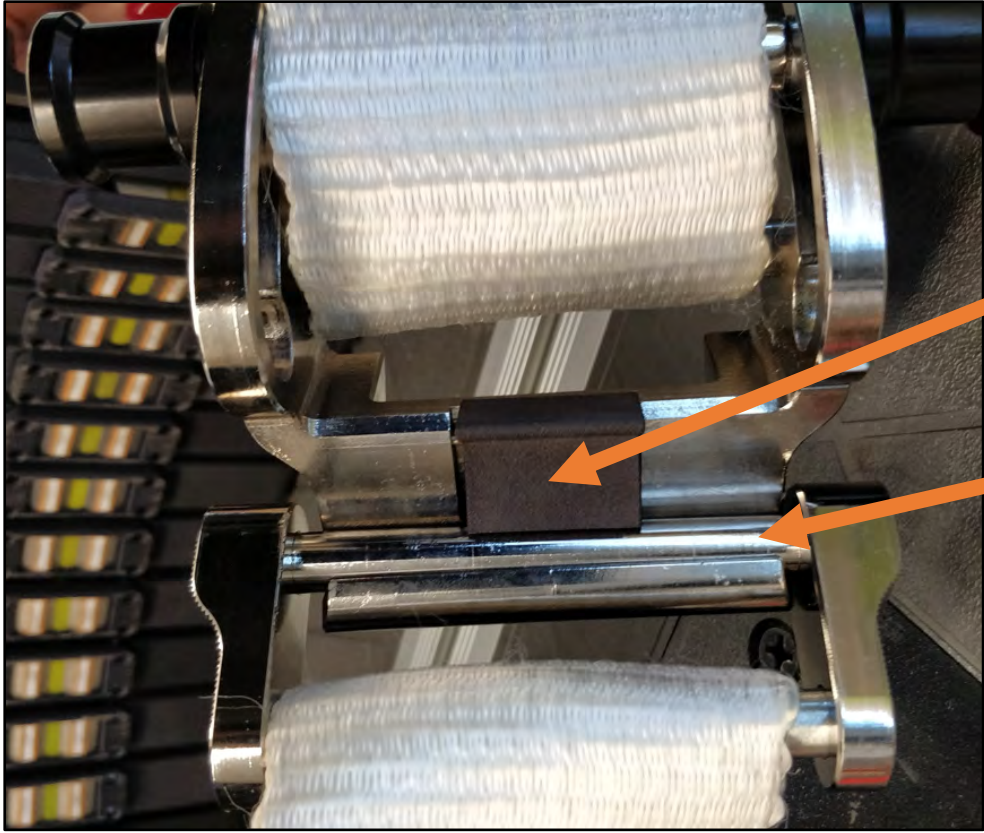

Plastic latch

Lift this part up. The buckle will now be in 2 parts, each attached to one extremity of the strap

2. Wrap the collar around the pipe and reattached both side of the buckle (make sure the black latch clicks properly).
3. Pre-tension the strap then slides the knobs in the locked position. If the knob cannot be moved deep into the locked position, reduce the pretension in the strap until the buckle can be safely locked.



UNLOCKED



LOCKED

## 4.1.4 Link-up collars

For pipe sizes of 26" (660mm) and above, two collars may be joined together. The following table lists the supported collar combinations. Combinations not listed in this table are not supported by the software.

NPS Pipe Size (in)	NPS Pipe Size (mm)	Collar 1 Size (in)	Collar 2 Size (in)	Total Modules
26	660	10	12	76
28	711	10	14	76
30	762	14	14	80
		12	14	80
32	813	16	14	88
34	864	16	16	96
		14	18	96
36	914	16	18	104
38	965	18	18	112
		16	20	112
40	1016	18	20	120
42	1067	20	20	128
		18	22	120
44	1118	20	22	128
46	1168	22	22	128
		20	24	136
48	1219	22	24	136
50	1270	24	24	144
		22	26	144
52	1321	24	26	152
54	1372	26	26	160
		24	28	152
56	1422	26	28	160
58	1473	28	28	160
60	1524	28	30	170
62	1575	30	30	180
		28	32	176
64	1626	30	32	186
66	1676	32	32	192
		30	34	186
68	1727	32	34	192
70	1778	34	34	192
		32	36	208
72	1829	34	36	208
74	1880	36	36	224



## 4.2 Magneto Tooling

Magneto-Tools, so-called as they utilise magnetostrictive technology provide the user with super light-weight compact tooling specifically designed for the inspection of small diameter pipes, a significant advantage being unrivalled signal to noise.



4" Magneto Tools in 64 & 128 kHz, and (Right) fitted to a pipe

There are 3 frequency options:

- **32kHz** – For inspection of high attenuation pipelines such as coated and buried pipelines.
- **64kHz** – For most above ground pipelines and standard for most applications.
- **128kHz** – For high resolution or high sensitivity inspections.

Deployment of Magneto-Tools differ to conventional piezo tools which use pneumatic pressure to bring the transducer array into contact with the pipe. Instead, Magneto-Tools apply the required pressure by clamping the tool onto the pipe with a clasp & bolt mechanism tightened to a pre-determined torque. For best performance and prevention of damage to the tool it is essential that a torque wrench is used. The required torque for all sizes is 12 Nm or (8.9 lbf·ft).

NPS Pipe Size (in)	NPS Pipe Size (mm)	Collar	Frequency Options
1.5	48.3	1.5" Magneto tool	32kHz 64kHz 128kHz
2	60.3	2" Magneto tool	32kHz 64kHz 128kHz
3	88.9	3" Magneto tool	32kHz 64kHz 128kHz
4	114.3	4" Magneto tool	32kHz 64kHz 128kHz

#### 4.2.1 Attaching the collar

To maintain peak performance the magneto-collars require periodic magnetic conditioning. It is recommended that this process be performed after every two to three tests.

To condition the collars, swipe the SMS conditioner three times around the internal surface of the collars ensuring that each pass is performed in the same direction.





Position the collar at the selected test location, taking note of the forwards orientation of the collar.



Pull the two ends together and hook the catch plate into the retaining screws.



Position the collar latch at the 0° position and tighten the screw by hand as far as possible.



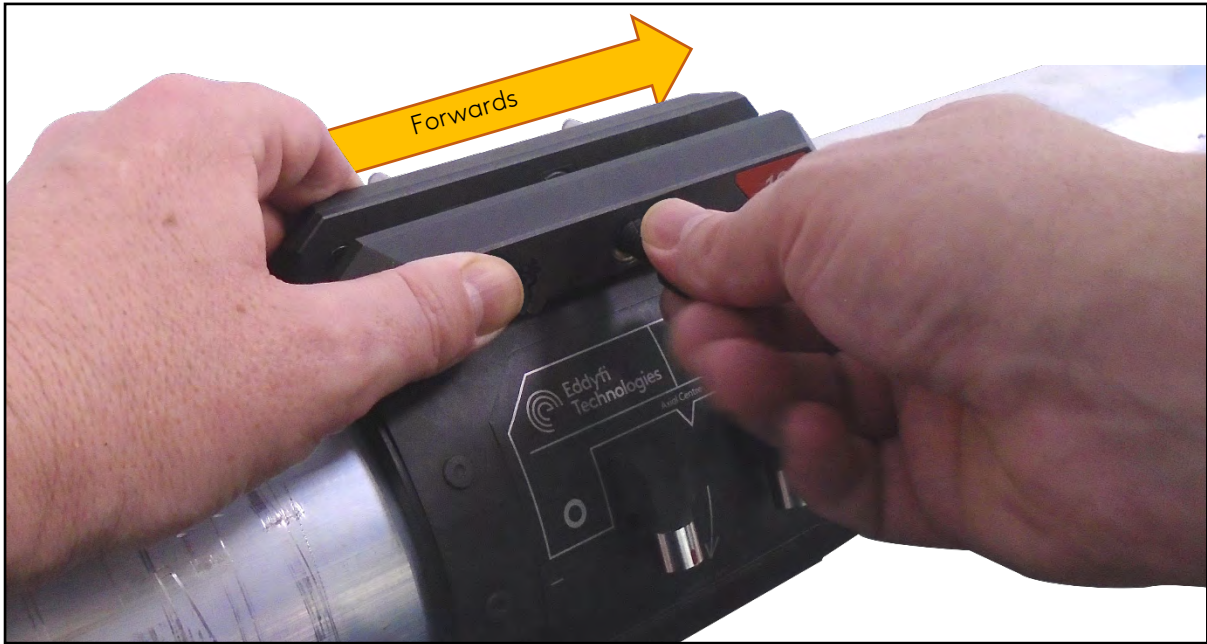

Use a torque wrench to fully tighten the screw to 12Nm.



**CAUTION:** Overtightening of the screw can result in damage to the internal coils and/or tool lead connectors.



## 4.3 Teletest Tooling

### 4.3.1 Teletest Collars (6" to 24")

The standard Teletest collars, Figure 31, range in diameter from 6" to 24" in 2" increments. They are designed to fit ASME standard pipe sizes, however, they can be adjusted to fit other pipe standards. In some cases, Teletest collars will be supplied with removable bladders. This allows the user to easily replace the bladder in the event of damage. Eddyfi UK limited document S-UG-5013, Assembly guidance for Teletest collars with removable bladders provides instruction for this process.



### 4.3.2 Attaching and inflating the collar

Refer to the Focus+/Series 3 collar user manual

### 4.3.3 Teletest Modules.

Standard Teletest modules are available in two (2) tooling options – Multimode and Torsional.

#### 4.3.3.1 Multimode Modules.



The Multimode modules, Figure 32, allow collection of both Torsional and Longitudinal wave modes with the same module. The modules connect into the Teletest collars with two (2) split pins and house five (5) transducers. Three (3) transducers are used during the Longitudinal collection with two (2)



spacing options (30mm and 46mm). The remaining two (2) transducers are used during the Torsional collection and have a transducer ring spacing of 30mm.

#### 4.3.3.2 Torsional Modules



The Torsional only modules have five (5) rings of transducers and have been specifically developed for use on pipelines exhibiting high rates of attenuation (coated / buried pipes) or on pipelines where the Longitudinal wave mode cannot be used such as pipes with a wall thickness in excess of 26.5mm or high-pressure water lines. The system comprises of two (2) three (3) ring transducer spacing options (30mm and 45mm).

## 4.4 OEM Tooling

The Sonyks is compatible with some OEM GWT tooling options. For information regarding the collar, modules, or transducers specification, refer to the OEM tool manufacturer documentation.

To connect the OEM tooling, one or both Lemo connectors to the tool and connect the I-PEX connector to the Sonyks in the usual fashion. The tool lead and type will be automatically detected.



**WARNING:** Do not start the data acquisition process without connecting or blanking off the Lemo connectors. Failure to do so may result in electric shock.

## 4.5 Tool Leads and air hoses

There are several types of tools that can be connected to the Sonyks instrument, each has its own tool lead. The tool leads and air hoses have a nominal length of 2.5m (8ft).

### 4.5.1 Sonyks Piezo Tool Lead

The tool lead used for the standard series 4 piezo tooling has an I-PEX connector on each end. The tool lead is polarised, it is important that the correct connectors are attached to the correct piece of equipment.

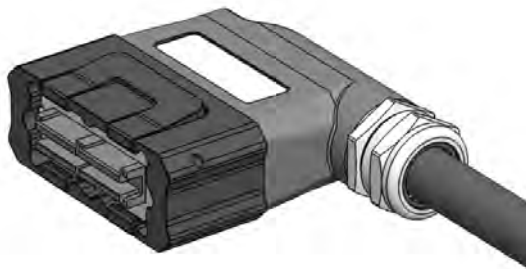

Instrument End

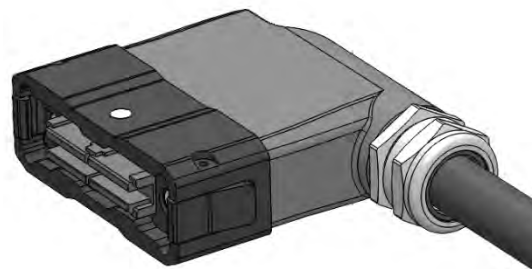

Tool End

The instrument end can be identified by the Eddyfi Technologies sticker, and the retaining clips are on the long edges of the connector. The tool end can be identified by the white dot, and the retaining clips are on the short edges of the connector.

#### 4.5.2 Sonyks Piezo Tool Lead Y

Its 2.5m to branch, with an extra 2m on each arm. This tool lead is used to connect two joined up collars (26in and above) to the Sonyks instrument.



#### 4.5.3 Sonyks Magneto

The Sonyks Magneto Tool lead has an I-PEX connector on one end and two Lemo connectors on the other end. The two Lemo connectors are marked with ○ ● symbols that match those on the collar connectors.

**NOTE:** When securing the dust caps for the Lemo connectors, ensure that the key and keyway align on the cap and the connector. Misalignment of these two parts may result in damage to the caps and/or the connectors.



#### 4.5.4 Sonyks Teletest

It has a female I-PEX connector on the instrument end and eight colour-coded and labelled 5 pin Lemo connectors at the collar. It can be used to connect the Sonyks instrument to Series 3 Teletest collars. When connecting a Series 3 mini-test collar, only use octants A, B, C & D.



#### 4.5.5 Sonyks to OEM tools

The Sonyks OEM Tool lead has an I-PEX connector on one end and two Lemo connectors on the other end. The two Lemo connectors are marked A on one connector and B/C on the other connector.

**NOTE:** When securing the dust caps for the Lemo connectors, ensure that the key and keyway align on the cap and the connector. Misalignment of these two parts may result in damage to the caps and/or the connectors.

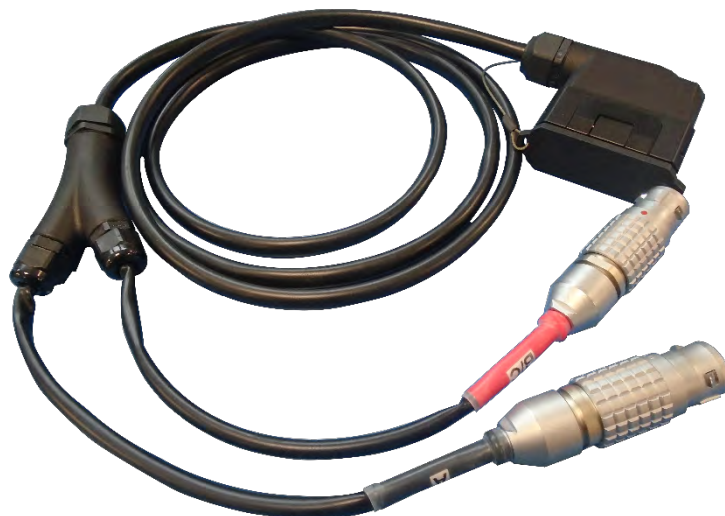

#### 4.5.6 Sonyks Air-Hose.

It has a non-return valve at the unit end and a Schrader valve at the collar end as shown in below.

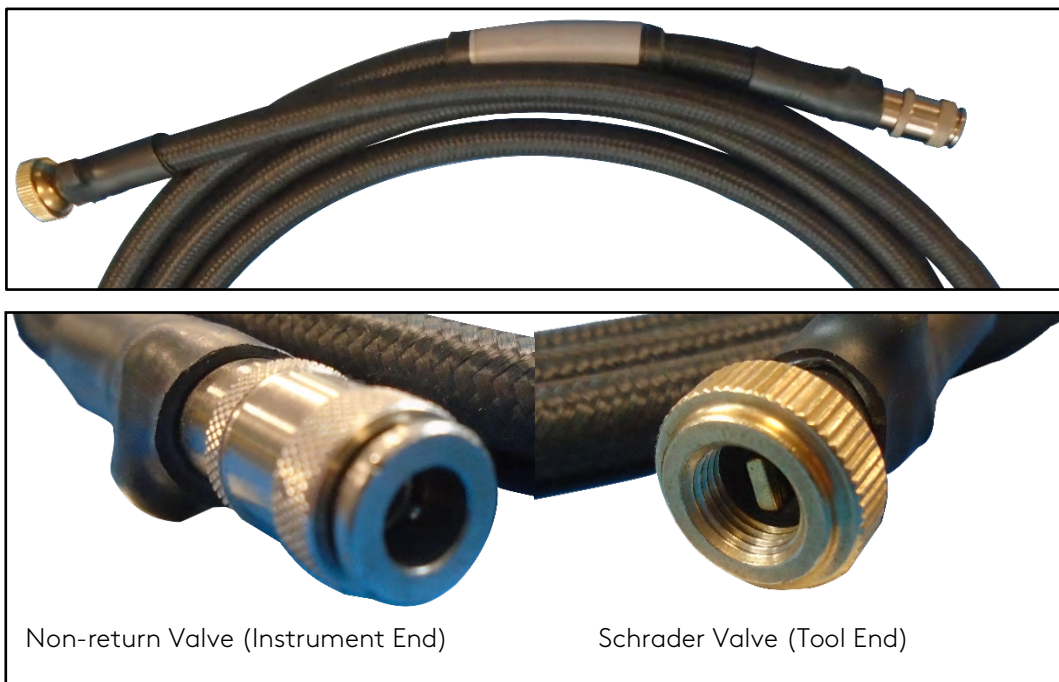

The air hose can be connected to the collar by screwing the Schrader Valve onto the fitting on the collar. The air hose can be connected to the instrument by pushing the instrument end of the hose onto the corresponding spigot on the instrument.

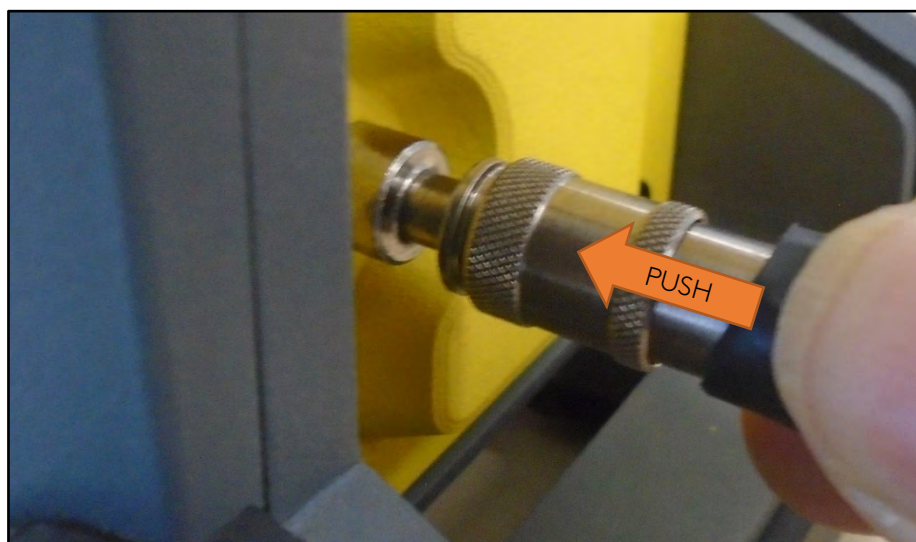

**IMPORTANT:** When connecting the air hose to the instrument ensure that the connector collar fully engages (drops) to lock the air hose in place.



Connector not engaged



Connector fully engaged

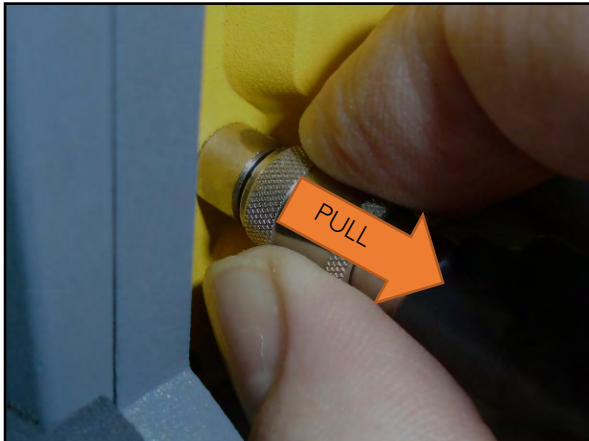

Lift collar to disengaged

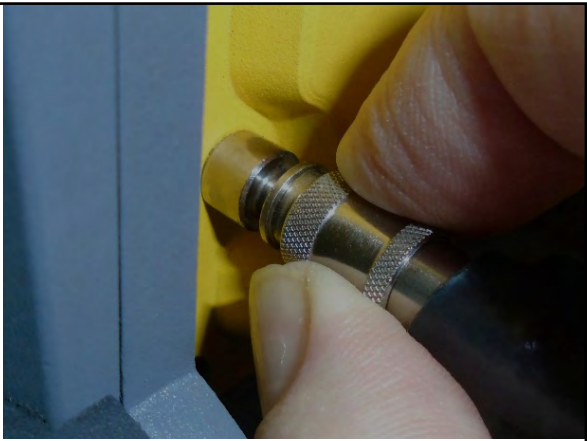

Pull to release

Lift the connector collar to disengage the air hose from the instrument.



#### 4.5.7 Sonyks Air-Y-hose for joined collars

Its 2.5m to branch, with an extra 2m on each arm. The connectors and fitment of this air hose is the same as for the single hose.

**NOTE:** Operating the pump with a single collar attached will result in a failure to inflate.

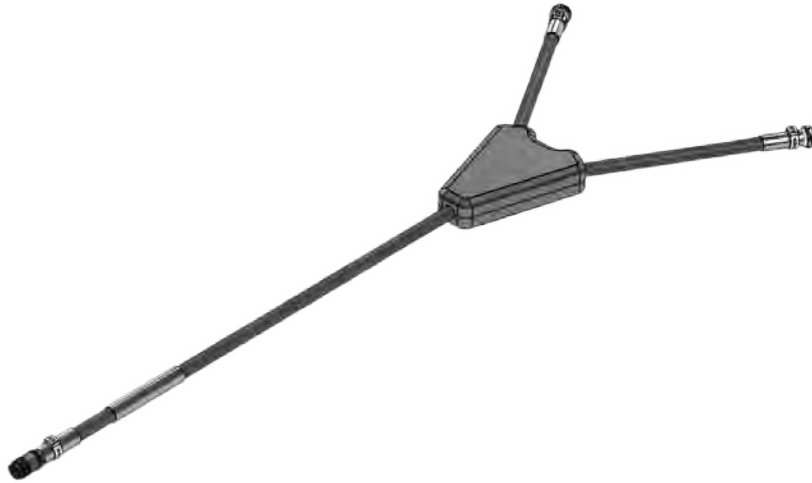

#### 4.5.8 Sonyks Air TT – Legacy Adaptor

The Legacy adaptor has a Schrader thread on one end that can be screwed into the Sonyks air hose, and an M8 thread on the other end that can be screwed onto a series 3 Teletest collar. For convenience, it is recommended that the adaptor is fitted to the collar first, the air hose can then be screwed to the adaptor.



Chapter 5

# Maintaining Sonyks

## 5. Maintaining Sonyks

Because of its design, Sonyks only requires minimal maintenance. Since it has no moving parts, it also does not require any preventive maintenance on your part. We recommend a regular inspection of the instrument to ensure it is properly grounded. We also strongly recommend an annual calibration and a factory-performed preventive maintenance by an officially qualified Eddyfi technician.

### 5.1 Cleaning Sonyks

- Make sure that the instrument is off, the batteries are removed, and that the power supply is disconnected.
- To bring the instrument back to its original finish, clean it with a soft cloth.

so  **WARNING:** Do not spray the instrument with chemical cleansers or water. Doing so may lead to short circuits and damage to the instrument.

**IMPORTANT:** To remove stubborn stains, use a soft cloth moistened with soap solution. Do not use abrasives or strong solvents as they could damage the finish.

- Wait until the instrument is completely dry before connecting the power cord, batteries, or cables.

### 5.2 Cleaning Tool Leads

- To bring the tool lead back to its original finish, clean it with a soft cloth moistened with soap solution. Stubborn stains and oil residues can be removed with a soft cloth moistened with isopropyl alcohol, acetone, or similar solvents.
- The connectors should only be cleaned with a contact cleaner spray. Do not insert any cleaning material into the contacts of the connector. Allow the contact cleaner to fully evaporate before using the tool lead.

### 5.3 Cleaning Collars and Modules

- Any mud should be allowed to dry, before brushing off with a stiff brush.
- Stubborn stains and oil residues can be removed with a soft cloth moistened with isopropyl alcohol, acetone, or similar solvents.
- Do not directly spray the collar or immerse it into water as damage may occur.
- Collar and module connectors should only be cleaned with contact cleaner spray. Allow the contact cleaner to fully evaporate before inserting the modules.

Chapter 6

# Updating and upgrading software

## 6. Updating and Upgrading Software

### 6.1 Sonyks PRO (PC)

- Download the Sonyks .exe installation file from our website. Save the file in an easy-to-remember location on your computer.
- It is recommended that previous versions of the Sonyks PRO software are uninstalled prior to installing the latest version.
- Double click on the .exe file to run the installation program.

### 6.2 Sonyks GO (Embedded)

Before you can perform any software maintenance, you must first meet the following requirements:

- USB storage device with a minimum of 1GB free space.

Or a

- Hardwired or wireless Internet connection

NOTE: Updates may not be performed if the batter has less than 50% charge.

There are two ways of updating or upgrading the software:

Via USB

- As a minimum, ensure that there is at least 50% charge in at least one battery. It is recommended, but not essential, that the power supply is connected during the update.
- Download the Sonyks \*.exe and \*.SonyksUpdate file from the Eddyfi Technologies website (<https://www.eddyfi.com/en/software/sonyks>). Save the files in an easy-to-remember location on your computer.
- Copy both files to the root of a USB mass storage device.
- Turn on Sonyks and wait for the software to start.
- Once copied, connect the USB storage device to any of the USB ports on the instrument. A dialog box will appear prompting you to proceed.
- Tap Yes.
- In the list that appears, tap the desired update file, and then tap Update. The Sonyks will restart once the update is complete.
- When the dialog box reappears informing you of an available update, click Cancel and remove the USB storage device. The Sonyks will start up normally.

Over Wi-Fi \ Ethernet

- As a minimum, ensure that there is at least 50% charge in at least one battery. It is recommended, but not essential, that the power supply is connected during the update.
- Ensure that the instrument is connected to the internet via either the ethernet connection or a Wi-Fi connection.

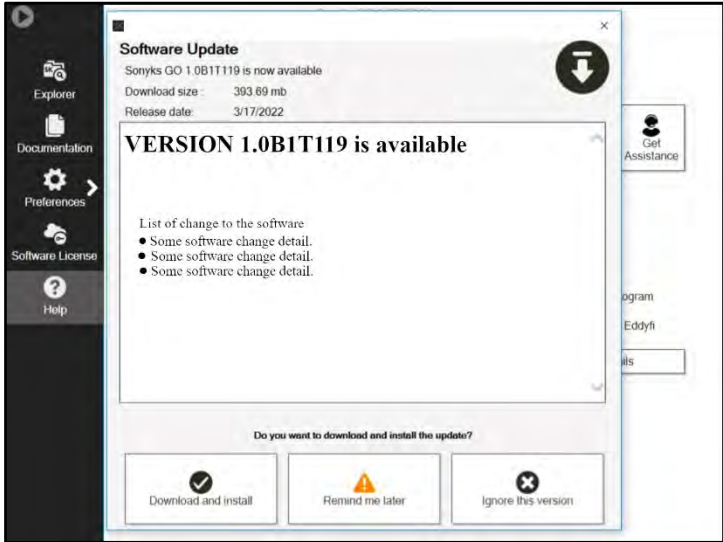

- From the Help menu item on the backstage, click the Check for Updates... button.
- If a new version is available there are three options:
  - **Download and install:** This will download and install the latest available version of the software.
  - **Remind me later:** This will remind you the next time you switch the instrument on that a new version is available.
  - **Ignore this version:** This update will be ignored, and no further reminders will be given. This option can be cancelled by pressing the Check for updates... button again.
- Select Download and install to upgrade the software. The download progress will be displayed onscreen. The download process may take several minutes depending on the connection speed.

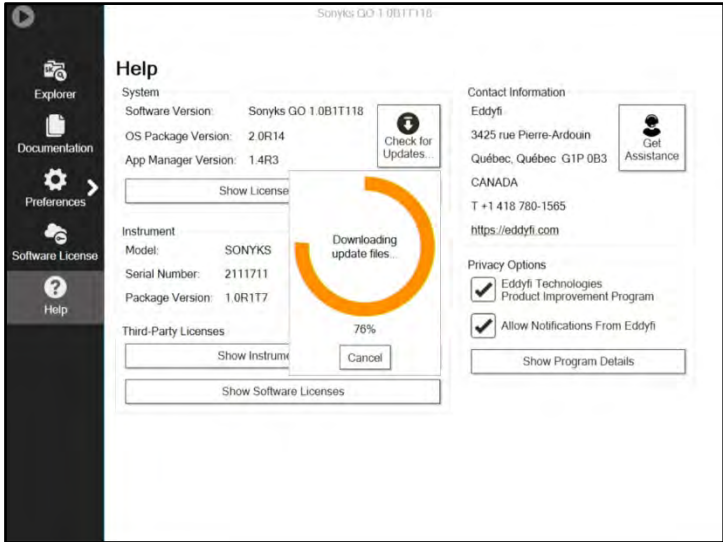



- Once the software has been downloaded it will be unpacked.
- A notification will be presented stating that an update is available on the local storage and asking if you wish to update.

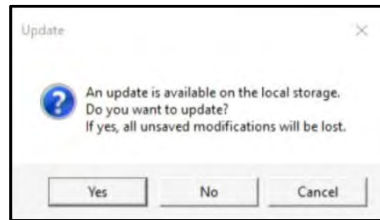

- Tap Yes to proceed.
- Both the update software and firmware versions will be shown.

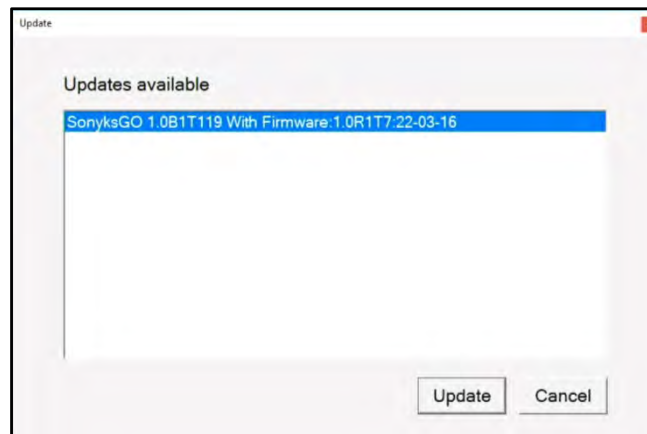

- Tap Update to install the update. The Sonyks will restart once the update is complete.

### 6.3 System Recover (Embedded)

The Sonyks recover system consists of four options:

1. Install EddyOS Update from USB key.

This option will install the latest version of EddyOS, the operating system software, onto the Sonyks hardware.

2. Install the factory EddyOS, keep data.

This option resets the Sonyks OS to the original version of EddyOS, the operating system software. Any test data stored on the Sonyks will be kept.

3. Copy all data to USB Storage.

This option allows all data to be transferred to a USB Storage device, prior to a full reset or OS upgrade.

4. Factory Default, all data will be lost.

This option is a full factory reset. The disk image will be wiped and both the OS and Sonyks software will be reinstalled with the original factory versions. All existing test data and software configurations will be lost. An update to the Sonyks software will be required after this option is used.

6.3.1 Initiating the Recovery System

- 1. Connect Sonyks to a power outlet with the power cable.
- 2. Make sure Sonyks is off. If it is not, turn it off.
- 3. Turn on the instrument.
- 4. Immediately and simultaneously press the TAB button and the A-SCAN SCALE buttons.



- 5. When the following message appears use the keypad arrows to highlight Enter Eddyfi System Recovery, and then press the "SELECT" button.



6. You are prompted to wait until the following appears.

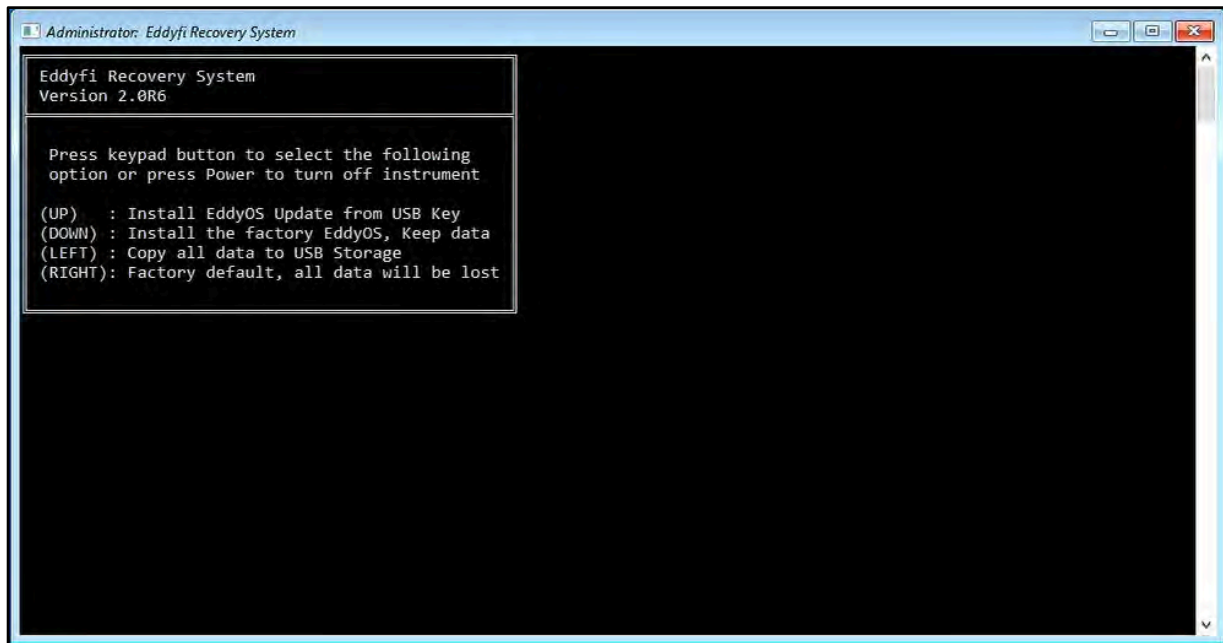

### 6.3.2 Install EddyOS Update from USB key

1. Using the keypad arrows, select Install EddyOS update from USB.
2. When prompted, press the up arrow of the keypad.
3. The update process starts. This normally takes between 5 and 10 minutes. When the process is complete, the system restarts.

### 6.3.3 Install the factory EddyOS, keep data

1. Using the keypad arrows, select Install the factory EddyOS update, keep data.
2. When prompted, press the up arrow of the keypad.
3. The update process starts. This normally takes between 5 and 10 minutes. When the process is complete, the system restarts.
4. Activate Windows.

### Activating Windows

Microsoft requires you activate Windows to be able to use it. The activation process is automatic when you connect Sonyks to the Internet through Wi-Fi or an Ethernet cable.

1. Make sure Sonyks is on, and that the software is running.
2. Either ensure that the Wi-Fi is on and connected to a network or use an Ethernet cable to connect the Sonyks unit to a network ((local area network or other access point).
3. Wait until a dialog box confirming the activation of Windows appears on screen.

If you do not activate Windows every time you start Sonyks, a message reminds you to do so. **YOU HAVE 30 DAYS TO ACTIVATE WINDOWS BEFORE IT LOCKS UP.**

#### 6.3.4 Copy all data to USB Storage

1. Insert a USB storage device into one of the USB ports.
2. Using the keypad arrows, select Copy all data to USB Storage.
3. All data stored on the instrument will be copied to the USB storage device.
4. When completed, press any key to return to the Recovery Options page.

**NOTE:** USB storage devices must be formatted using the FAT32 file system, not NTFS.

#### 6.3.5 Factory default, all data will be lost

1. Using the keypad arrows, select Install the factory EddyOS update, keep data.
2. When prompted, press the up arrow of the keypad.
3. The update process starts. This normally takes between 5 and 10 minutes. When the process is complete, the system restarts.
4. Connect to a network.
5. Check that the time zone, time, and date are correct.
6. Activate Windows.
7. Install the latest version of the Sonyks software.

### Known Issues with System Updates/Upgrades

On some units, a blue Windows error screen may appear when you attempt to enter the system recovery, which can cause the unit to start normally. Try performing the update procedure again.

Chapter 7

# Troubleshooting

## 7. Troubleshooting

### Troubleshooting System Updates/Upgrades

#### No update file found

This appears in the update list or in the system recovery. Make sure that you only have one USB mass storage device connected to Sonyks. Also make sure that the file is in the root folder of the device.

#### Cannot display the options screen

There may be several reasons for this to appear:

- You did not press and hold the **TAB** button and the **A-SCAN SCALE** button long enough.
- You did not press and hold the correct buttons.
- You did not press and hold the buttons quickly enough after turning on Sonyks.
- Try holding the power button for two seconds, and then quickly pressing and holding the **TAB** button and the **A-SCAN SCALE** button.

Using the system recovery method, Sonyks restarted normally, or a blue error screen appeared on the screen

- Perform the procedure again.

#### Unable to activate Windows

- If using Wi-Fi, ensure that it is switched on and connected to a network.
- If using LAN, ensure your Ethernet cable is sound.
- Ensure that you have Internet access.
- Ensure that your network uses DHCP.
- After connecting the Ethernet cable to the network, turn on Sonyks.
- When the Sonyks starts up, if you do not see a message warning you Windows is not activated then Windows has been activated.



Chapter 8

# Specifications

## 8. Specifications

SONYKS INSTRUMENT	
Dimensions (W × H × D)	355 × 288 × 127 mm (14.0 × 11.3 × 5.0 in)
Weight (with 1 × battery)	7.2 kg (15.9 lb)
Power Supply	<p>Power supply source: External power supply unit and/or removable batteries.</p> <p>External AC/DC power supply: 240V/50Hz, 110V/60Hz, 0.6-1.5A</p> <p>Instrument power supply: 15Vdc, 100W</p> <p>Battery power supply: 10.8V 8.7Ah Li-Ion rechargeable (6-8h autonomy from 2 batteries).</p>
Video Output	HDMI
Number of Channels Transmit	40
Transmitter Frequency Range	5–260 kHz
Standard Output Voltage	200V, peak-to-peak
Number of Channels Receive	40
Receiving Gain Range	Up to 100 dB
Maximum Sample Range	365 m: longitudinal in pulse-echo or 200 m: torsional in pulse-echo
Maximum Number of Averages	128
Focusing Options	C-Scan imaging, time delay focusing
Display	<p>26.4 cm (10.4 in)</p> <p>Non reflective (AR coating)</p> <p>Anti-fingerprint (oleophobic coating)</p> <p>3 mm (1/8 in), chemically strengthened glass cover</p> <p>Optically bonded LCD and touchscreen</p> <p>Passive backlight enhancement</p>
Software Options	<p>Sonyks GO (Instrument)</p> <p>Sonyks PRO (Optional Laptop Control)</p>
Laptop Connectivity	Optional connection through Wi-Fi or Gigabit Ethernet
Storage	256 GB, SSD
Cooling	Sealed and internal fan
Onboard Pump	60 PSI maximum pressure
Onboard Collar Pressure Monitoring	Yes
GPS	Accurate positioning to 2.5 m (8.2 ft)

SONYKS INSTRUMENT	
Instrument Transduction Compatibility	Magnetostrictive and piezoelectric transducer compatibility
Supported Rings	Sonyks Piezo and Magneto tools, Teletest and other commercial PZT rings
Probe Recognition and Setup	Automatic with Sonyks tooling including ring type, size, serial number, pipe, and angular orientation
Maximum Sample Range	125 ms
Automated Self-check	Onboard capacitance testing
Radio Power Rating	2.4000–2.4835 GHz, max. 100 mW The low band 5.15–5.35 GHz is for indoor use only.

ENVIRONMENTAL (Instrument & Collar)	
Intend usage	Indoor / Outdoor
IP Rating	IP rating <ul style="list-style-type: none"> <li>• Instrument: IP54*</li> <li>• Collars: IP2x</li> </ul> * With caps on unused connectors and doors closed
Operating Temperature	0–40°C (32–104°F)
Operating Humidity	95%, non-condensing
Compliance	IEC 61010-1, CE, UKCA, WEEE, FCC Part 15, ICES-001
Altitude	2000m max.
Pollution Degree	2

Piezo Tooling (Sonyks)	
Piezo Tooling – Transduction Method	Piezoelectric transducers (PZT)
Piezo Tooling – Frequency Range	20–80 kHz broadband collection
Piezo Tooling – Pipe Size Range	15.2–91.4 cm (6–36 in) single collar 66–182.9 cm (26–72 in) dual collar setup
Piezo Tooling – Sensors	Automatic collar recognition, pipe size, orientation, and angular position
Piezo Tooling – Max. Surface Temp.	120°C (248°F)

Magneto Tooling	
Magneto Tooling – Transduction Method	Segmented Magnetostrictive Sensors (SMS)

Magneto Tooling	
Magneto Tooling – Frequency Range	32 kHz – Test range 22–42 kHz 64 kHz – Test range 54–74 kHz 128 kHz – Test range 108–142 kHz
Magneto Tooling – Pipe Size Range	38, 51, 76 and 102 mm (1.5, 2, 3 and 4 in)
Magneto Tooling – Maximum Surface Temperature	80°C (176°F) 120°C (248°F) short term

Teletest Tooling (Legacy collar)	
Teletest Tooling – Transduction Method	Piezoelectric transducers
Teletest Tooling – Pipe-size	152–610 mm (6–24 in) single collar 660–1321 mm (26–52 in) double collar set-up 1372–1981 mm (54–78 in) triple collar set-up
Teletest Tooling – Frequency Range	20–80 kHz depending on spacing and wave mode
Teletest Tooling – Maximum Surface Temperature	Standard 120°C (248°F) High Temperature (HT) 240°C (464°F)
Teletest Module – Wave mode Compatibility	Multimode 3 ring torsional – 30 mm (1.2 in) 3 ring torsional – 45 mm (1.8 in)

The information in this document is accurate as of its publication. Actual products may differ from those presented herein.  
© 2022 Eddyfi UK Ltd. Eddyfi Technologies, Eddyfi, Teletest, Sonyks, Magneto-tooling, Wavescan, and their associated logos are trademarks or registered trademarks of Eddyfi Canada, Inc. in the United States and/or other countries. Eddyfi Technologies reserves the right to change product offerings and specifications without notice. Eddyfi Technologies is a Previa Business Unit.

[eddyfi.com/sonyks](https://eddyfi.com/sonyks)

[info@eddyfi.com](mailto:info@eddyfi.com)

